

**Technische Daten: Art.-Nr.: 536150**

**Wandaußenmaß: 703 x 299 cm**

**Bohlenstärke: 40 mm**



**Dieses Haus lässt sich auch spiegelverkehrt aufbauen.  
Darum ist es erforderlich, die Fußbodenbretter im Eingangsbereich  
laut beigefügter Zeichnung selbst zuzuschneiden.**

Kontrolliert durch:

Achtung: Alle angegebenen Maße sind ca.-Maße!

# 3D-Darstellung 536150

Das Haus läßt sich auch spiegeverkehrt aufbauen. Darum ist es erforderlich, die Fußbodenbretter und Terrassenbretter im Eingangsbereich laut beigefügter Zeichnung selbst zuzuschneiden.

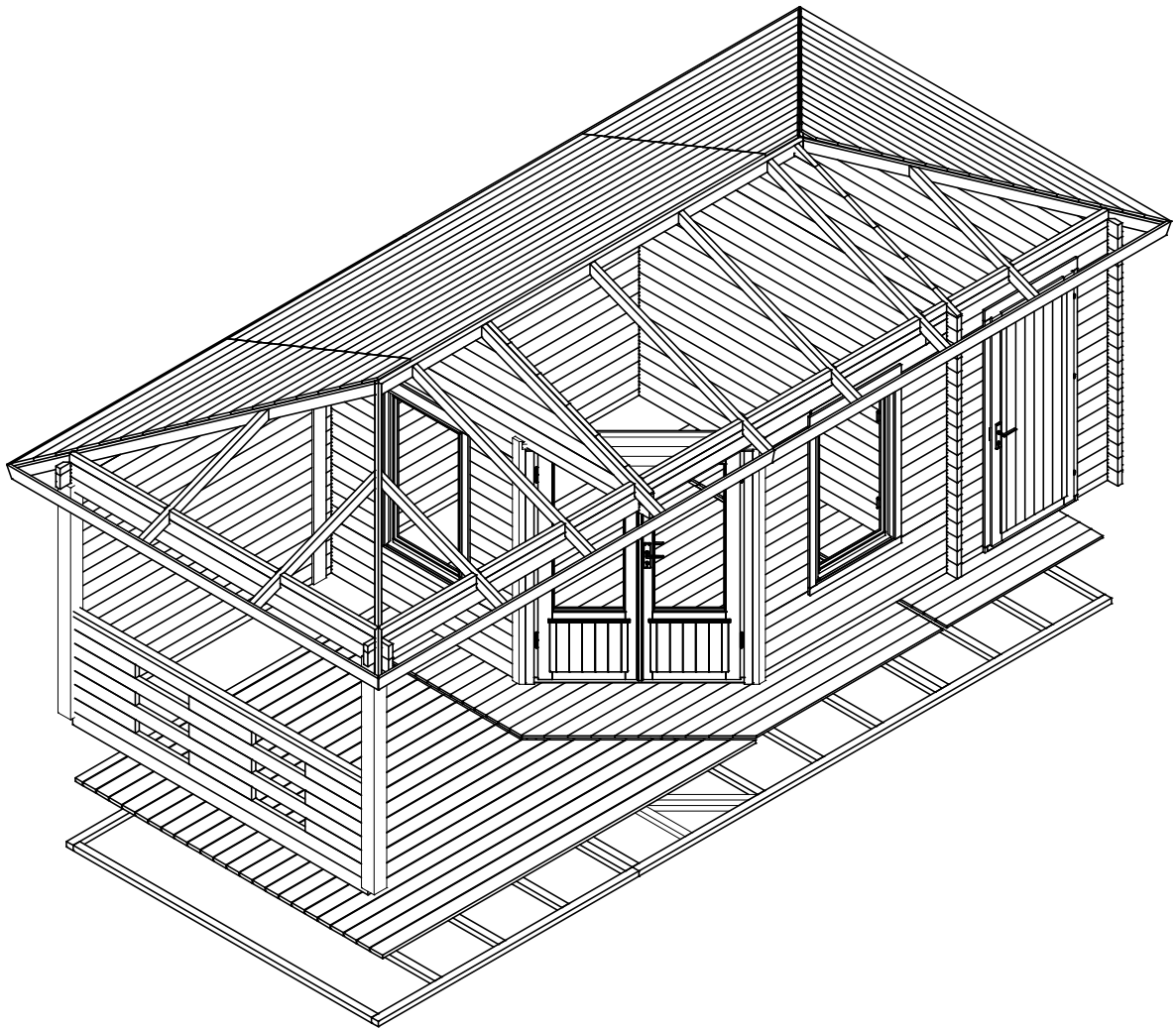

# Grundriss 536150

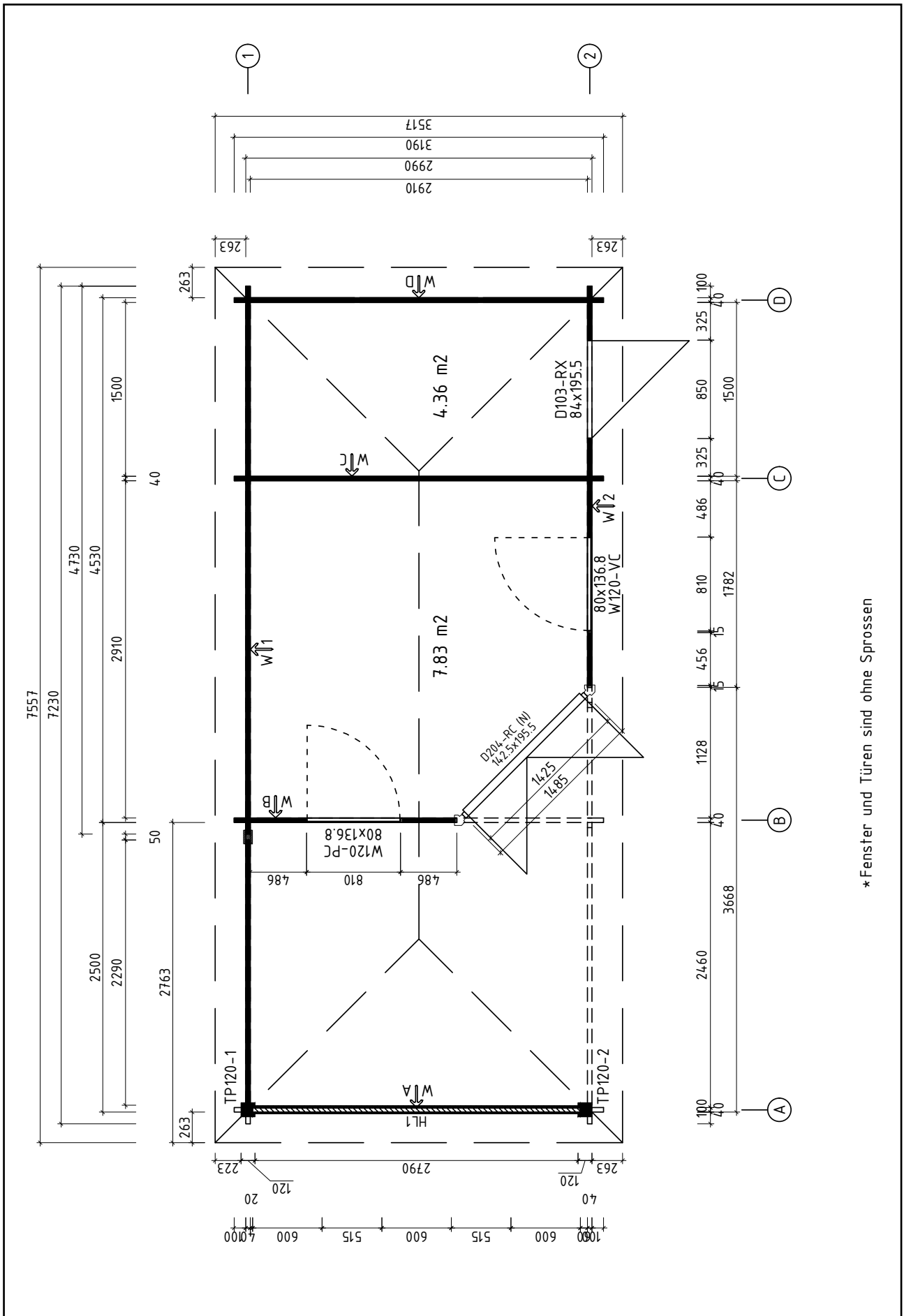

\* Fenster und Türen sind ohne Sprossen

# Lagerholzplan und Fundamentplan 536150

Wir empfehlen als Fundament für Ihr Gartenhaus eine vollflächig festgegründete, gepflasterte oder betonierte Fläche.  
Wahlweise ist auch ein Punkt- oder Streifenfundament möglich.

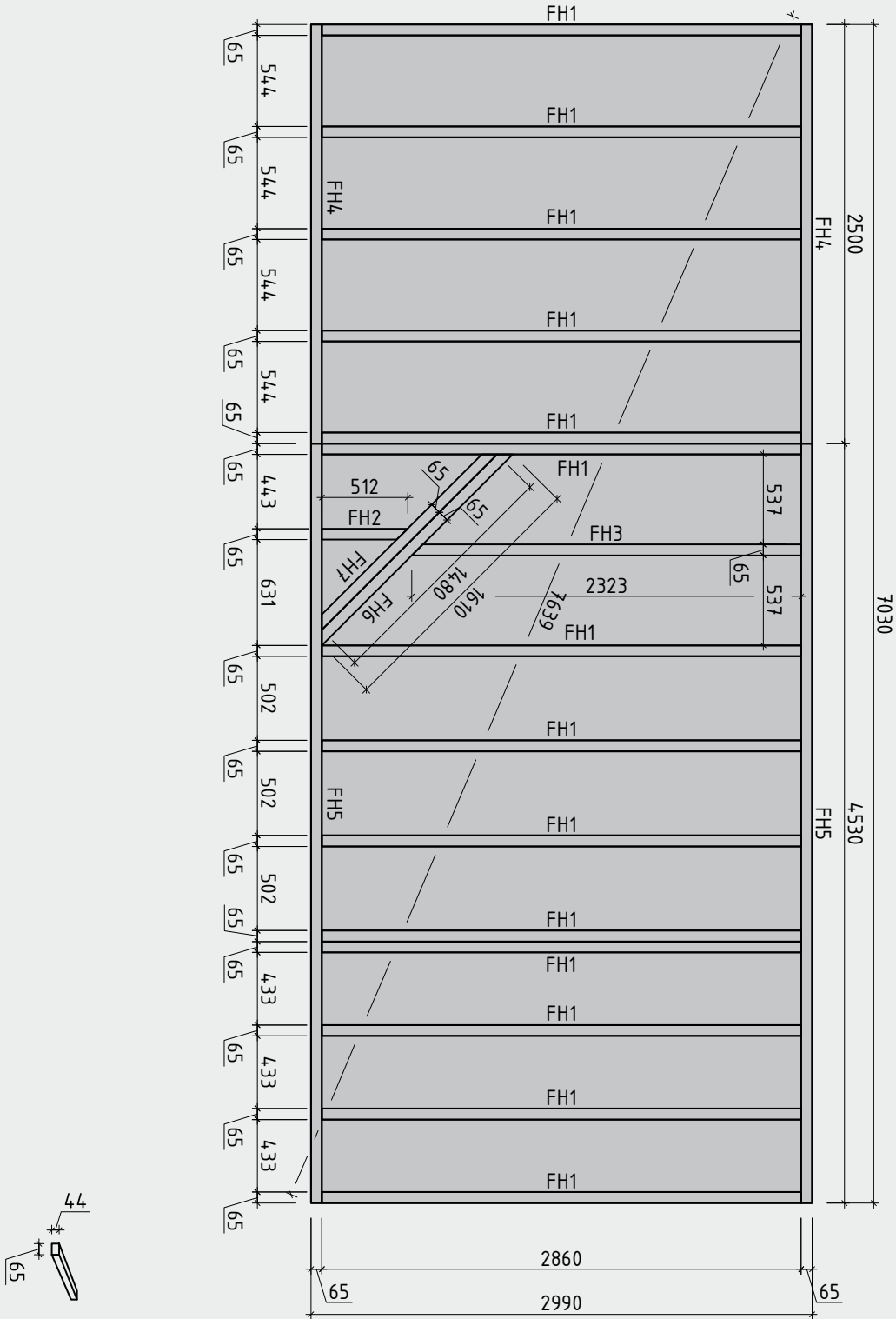



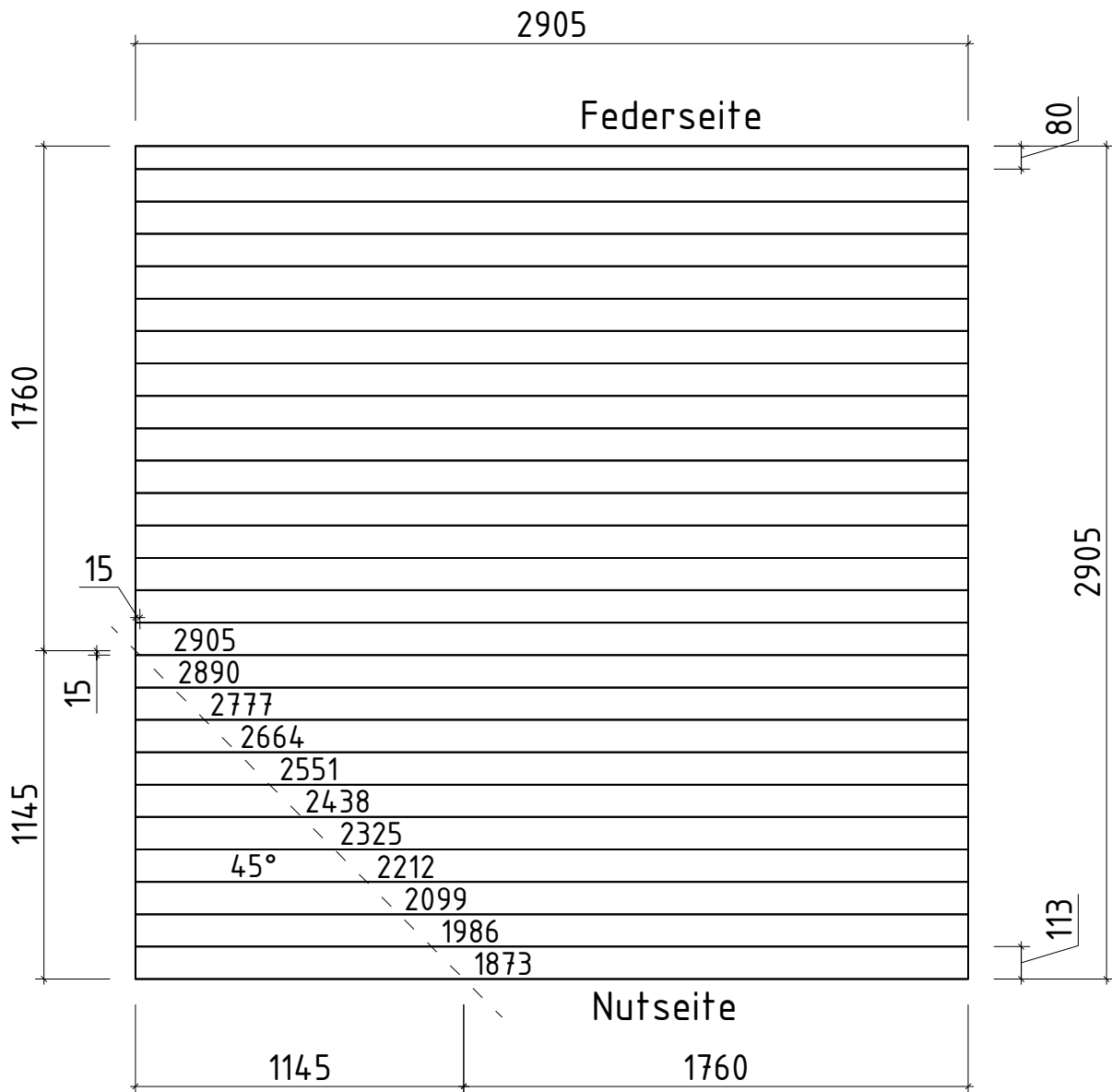

# Detailansicht Fußboden 536150

Zuschneiden der  
Fußbodenbretter 113x18mm



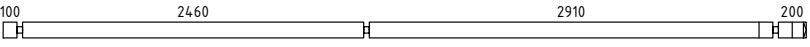

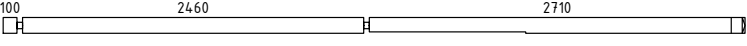
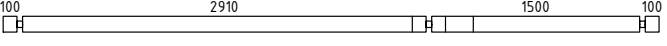
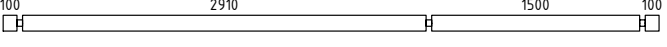
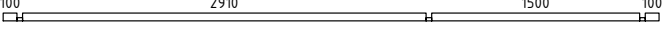
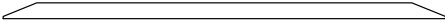
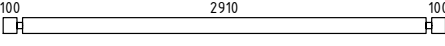
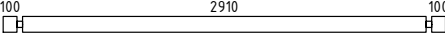
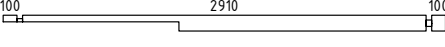
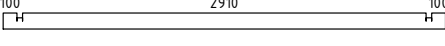

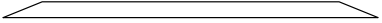
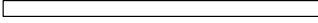
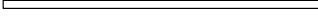
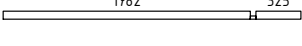
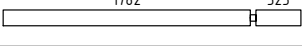
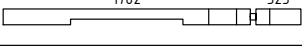
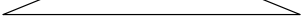
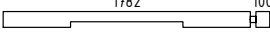
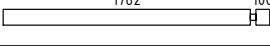
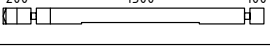
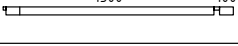
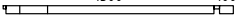





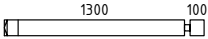
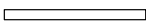
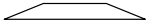
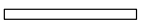

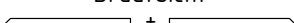
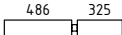







# Teileliste 1

## 536150

Pos		Stck	Profil (mm)	Länge (mm)
001		1	40x114	5790
002		1	40x57	5570
003		1	40x57	5570
004		1	40x114	5350
005		1	40x114	4730
006		16	40x114	4730
007		1	40x57	4730
008		2	40x114	3190
009		2	40x114	3190
010		38	40x114	3190
011		1	40x114	3190
012		1	40x114	3190
013		5	40x114	2830
014		2	40x114	2704
015		17	40x114	2290
016		1	40x57	2290
017		1	40x57	2147
018		4	40x114	2147
019		1	40x114	2147
020		2	40x114	2142
021		1	40x114	1922
022		4	40x114	1922
023		1	40x114	1880
024		1	40x57	1660
025		1	40x57	1660



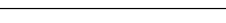











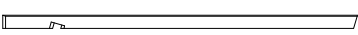
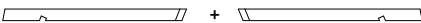

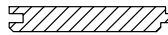
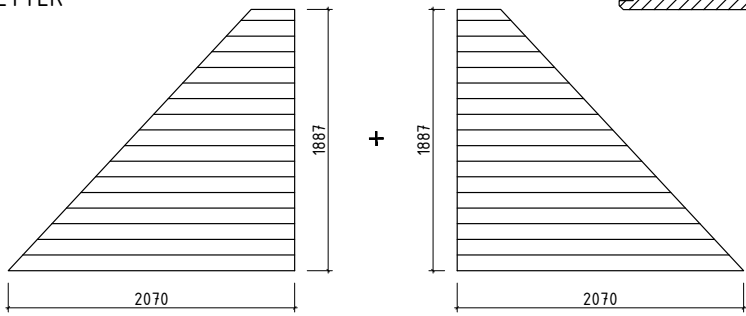
# Teileliste 2

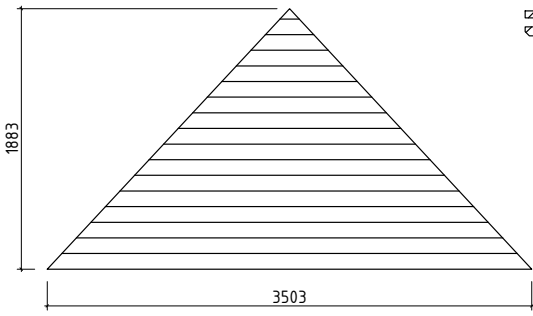
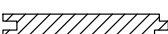
## 536150

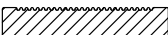
Pos		Stck	Profil (mm)	Länge (mm)
026		2	40x114	1580
027		1	40x114	1440
028		2	40x72	1020
029		2	40x114	1017
030		2	40x72	953
031	 Draufsicht 	✓ 4+4	40x72	910
032		12	40x114	851
033		6	40x72	807
034		12	40x114	626
035		2	40x72	620
036		9	40x114	600
037		2	40x72	555
038		17	40x114	465
039		1	40x57	465
040		24	40x114	456
041		2	40x72	212
042		2	40x80	197
043		2	40x80	197
FH5	FUNDAMENTHÖLZER (imprägniert) 	2	65x44	4530
FH1	FUNDAMENTHÖLZER (imprägniert) 	14	65x44	2860
FH4	FUNDAMENTHÖLZER (imprägniert) 	2	65x44	2500
FH3	FUNDAMENTHÖLZER (imprägniert)  45°	1	65x44	2323
FH6	FUNDAMENTHÖLZER (imprägniert) 45°  45°	1	65x44	1610
FH7	FUNDAMENTHÖLZER (imprägniert) 45°  45°	1	65x44	1480
FH2	FUNDAMENTHÖLZER (imprägniert)  45°	1	65x44	512

# Teileliste 3











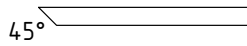

## 536150

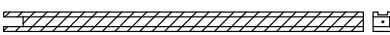
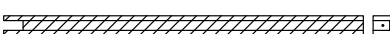
Pos		Stck	Profil (mm)	Länge (mm)
HL1	HANDLAUF 	✓ 1	65x44	2830
LE1	LEISTE 	4	15x40	1358
SPR1	SPARREN 	10	44x85	1879
FPF1	FIRSTPFETTEN 1036 2910 76 	1	62x105	4102
GSP1	GRATSPARREN 	4	44x94	2564
SFT1	SCHIFTER 	4+4	44x85	1329
	DACHBRETTER 	34+1	113x18	3400
	DACHBRETTER  	2+2	113x18	
	DACHBRETTER  	2	113x18	
	FUSSBODENBRETTER 	✓ 26+1	113x18	2905
	FUSSBODENBRETTER 	26	113x18	1495
	TERRASSENBRETTER (imprägniert) 	✓ 9+1	120x28	3578-2578
	TERRASSENBRETTER (imprägniert) 	15	120x28	2455
	FUSSBODENLEISTEN 	✓	18x40	21,0 lfdm
A40-1	ADAPTER 40 Obere seite 	✓ 1	120x76	2110
T02-1	TRAUFENBRETTER 18x120 	✓ 2	18x120	3615
T02-2	TRAUFENBRETTER 18x120 	✓ 2+2	18x120	3825

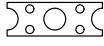

# Teileliste 4

## 536150

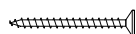
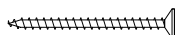
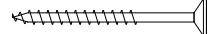
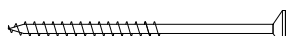
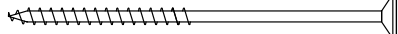
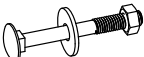
Pos		Stck	Profil (mm)	Länge (mm)
DzT 40-1	ECKTÜR- Deckbrett zum Tür 40 	1	18x40	1585
VK1-1	ECKTÜR- Verkleidungsleisten 58 für Vordachelement   ✓	2	58x12	1110
P9L1-1	ECKTÜR- linke Türpfoste 40 	1	90x90	2015
P9R1-1	ECKTÜR- rechte Türpfoste 40 	1	90x90	2015
VE1	ECKTÜR- Vordachelement 1435x745 	1		
TP1 20-1	STÜTZPFOSTEN 120x120  ✓	1	120x120	1925
TP1 20-2	STÜTZPFOSTEN 120x120  ✓	1	120x120	1925
SM-1	Sturmleisten 	4	18x40	2050
SH	Schlaghölzer 	3		
ML1	Metallstange 	6	D10	240
HK1	HOLZ-KLOTZEN für verbinden der Wandbohlen (104mm) 	2		
VS	VERBINDUNGSTREIFEN für verbinden der Wandbohlen 	2		
VP2	Verstellbare Pfostenstütze M16 	2		
NG04	NÄGEL 2.5x50 Dachbretter Fußbodenbretter 	1592		
NG05	NÄGEL 2.5x60 Terrassenbretter 	288		
SR32	SCHRAUBEN 3.0x30 Fußbodenleisten 	42		
SR37	SCHRAUBEN 3.5x45 Traufenbretter Handlauf, LE1 Deckbrett, Verkleidungsleisten Verbindungsstreifen Türleisten 	156		
SR44	SCHRAUBEN 4.0x60 Stützpfeosten 	8		
SR55	SCHRAUBEN 5.0x70 Stützpfeosten SPR1, GSP1, SFT1 Pos 017 und 022 (1. Bohlenreihe neben die Tür) 	38		
SR57	SCHRAUBEN 5.0x100 Fundamenthölzer SPR1, GSP1, SFT1 Pos 011, 028, 030, 031, 033, 035, 037, 041 	160		
SR61	SCHRAUBEN 6.0x140 Pos 003 	5		
SS13	Schloßschrauben M8x70 Mutter M8 U-Scheibe Ø25 - Befestigung für Sturmleisten 	12		

# Teileliste 5

## 536150

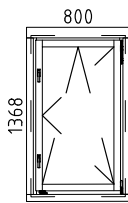
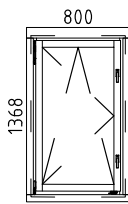
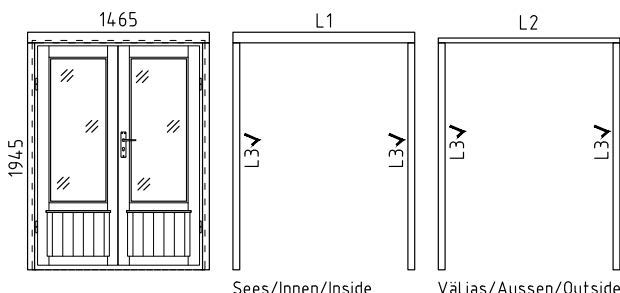
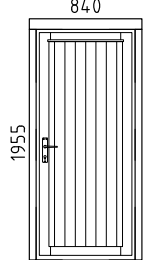
Pos		Stck	Profil (mm)	Länge (mm)
	<p>FENSTER 800x1368</p>  <p>W120-PC DIN rechts</p>	1		
	<p>FENSTER 800x1368</p>  <p>W120-VC DIN links</p>	1		
	<p>TÜR 1425x1955</p>  <p>D204-RC</p> <p>L1 18x90 L=1540mm 1x L2 18x40 L=1540mm 1x L3 18x58 L=1925mm 4x ✓</p> <p>DIN rechts</p> <p>Sees/Innen/Inside      Väljas/Aussen/Outside</p>	1		
	<p>TÜR 840x1955</p>  <p>D103-RX DIN rechts</p>	1		
	✓ - bitte selber anpassen (falls nötig)!			



# Wandplan A 536150

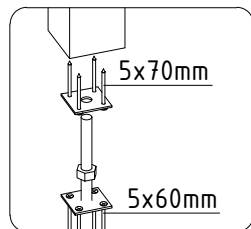
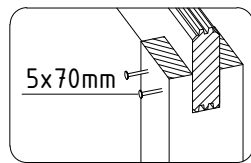
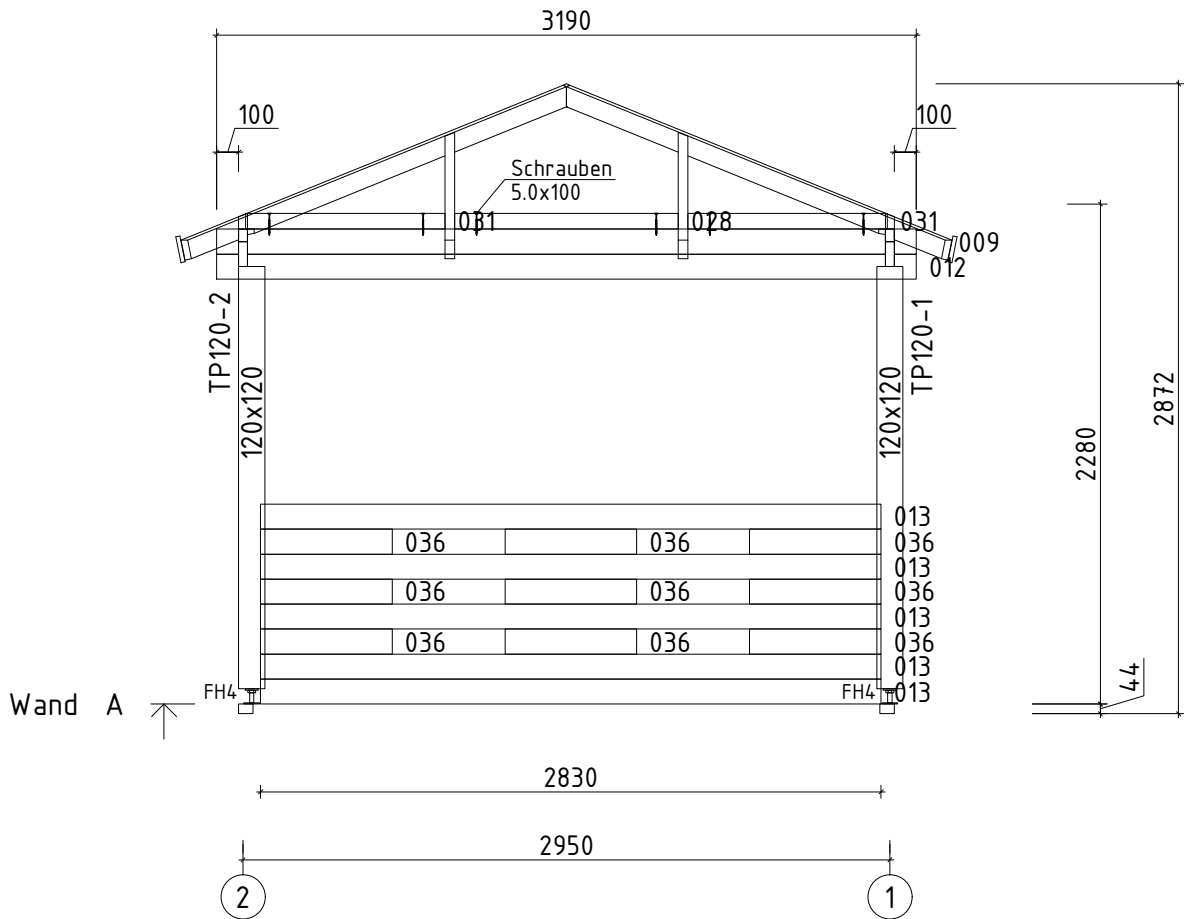



# Wandplan C 536150

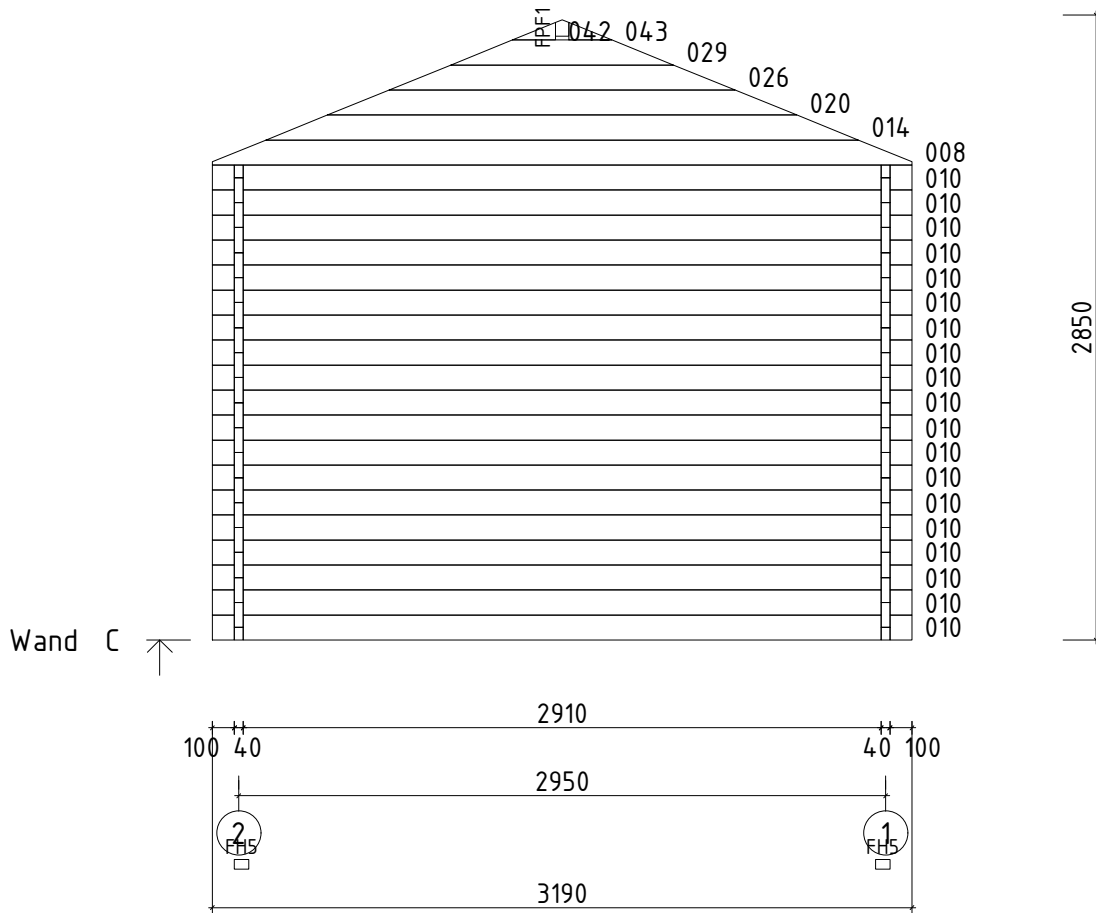

# Wandplan D

## 536150

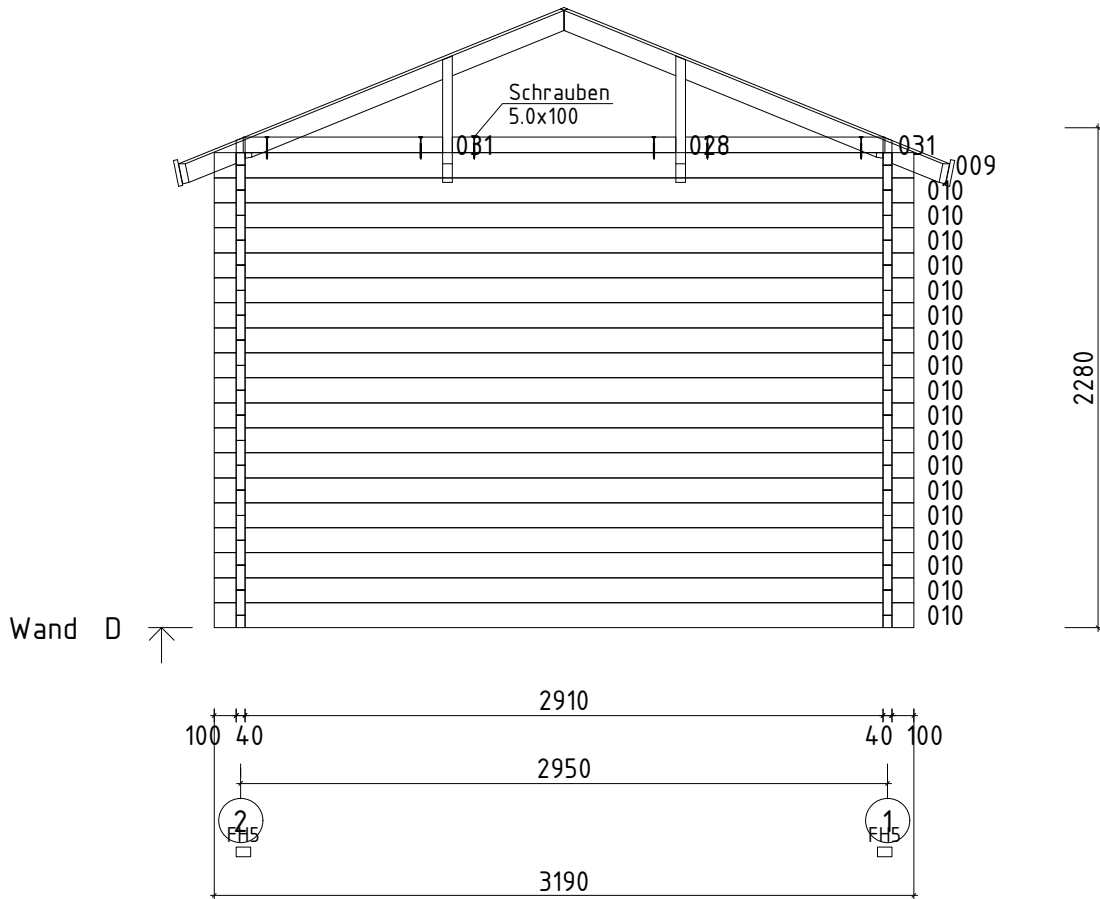

# Detail Terrasse

## 536150

Zuschneiden der  
Terrassenbretter 120x28mm

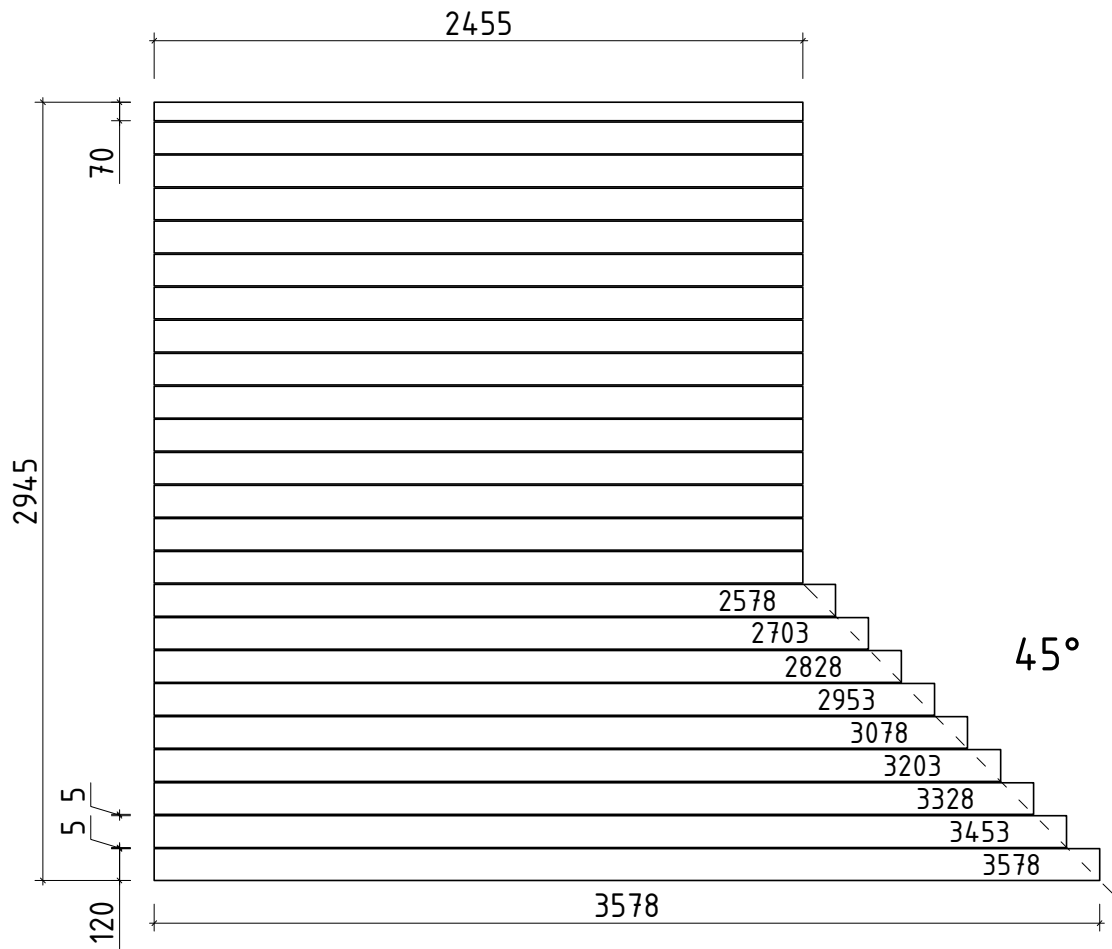



# Detail Dach 536150

Step 1: Dachelement an den Wänden verschrauben.  
Step 1: Screw canopy element to the wall.

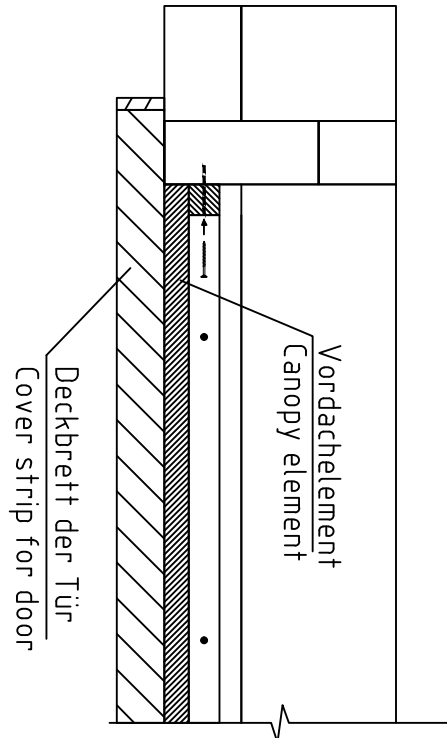

Step 2: Das Deckbrett muss von oben (durch das VD-Element) an das Dachelement verschraubt werden.  
Step 2: Fasten cover strip to the canopy element.

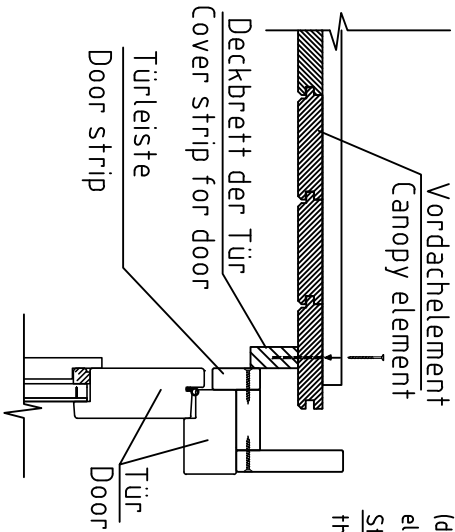

Step 3: Die Verkleidungsleisten in die richtige Länge schneiden und unter das VD-Element befestigen.  
Step 3: Cut trim strips to size and fasten under the canopy element.

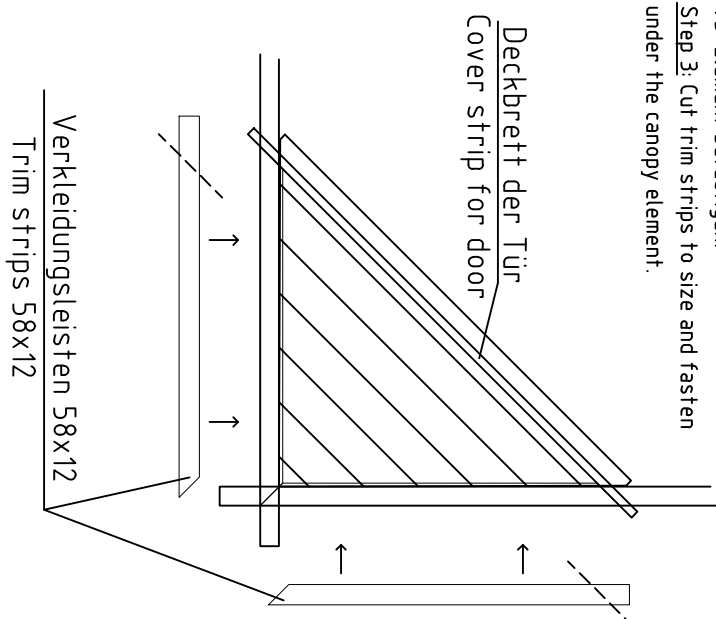

# Spiegelverkehrte Montage

## 536150

Tip wenn spiegelverkehrt.  
Tip for mirrored installation.

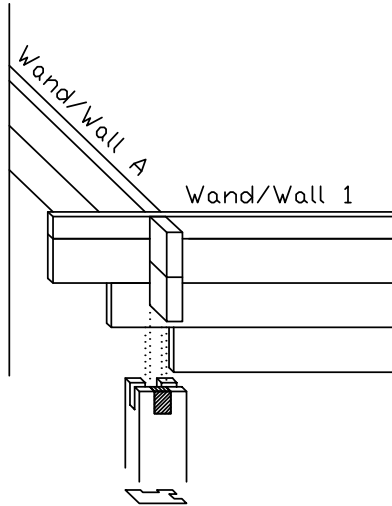

spiegelverkehrt  
mirrored

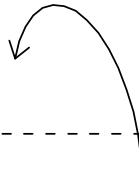

Wenn das Haus spiegelverkehrt dann  
das Klotze (wie auf Zeichnung 1.)  
machen, wie auf Zeichnung 3.

In case of mirrored installation the  
filling tile needs to be moved as shown  
in pictures 1. to 3.

Standard

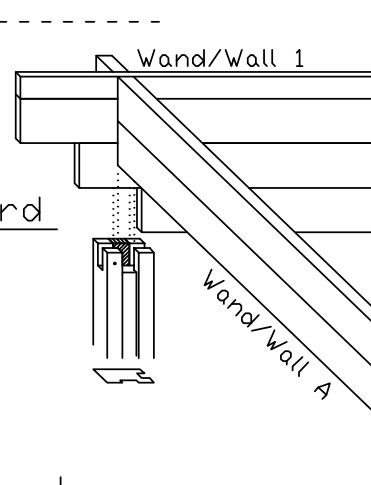

1.

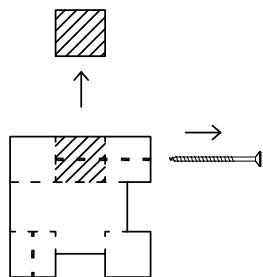

2.

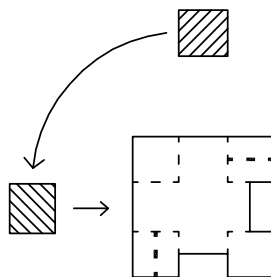

3.

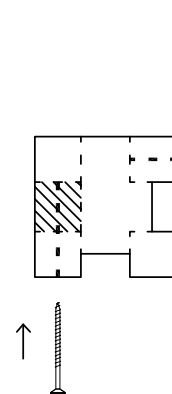

# Türmontage 536150

Ükse montaaž / Tür montage / Door assembly  
(GH+ / SH)

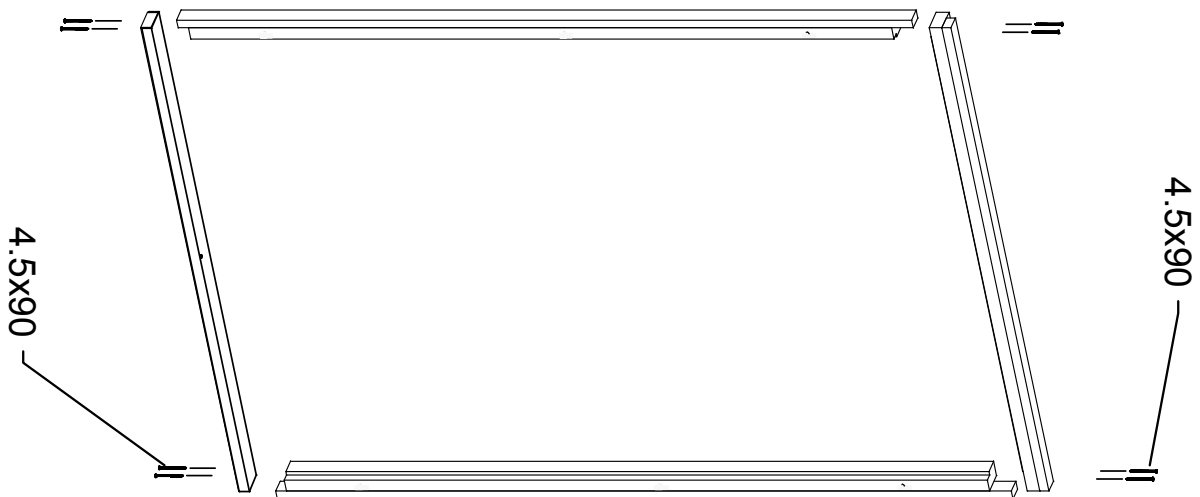
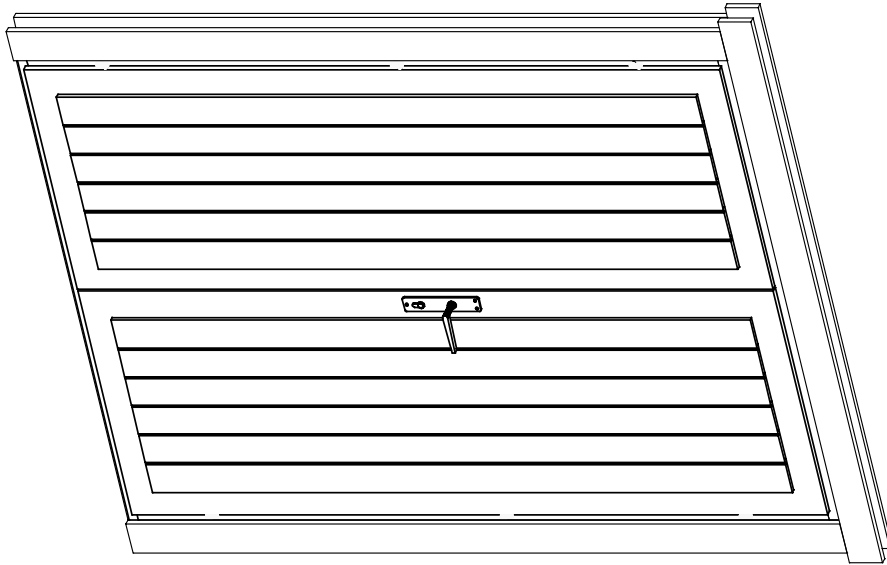

# Türmontage 536150

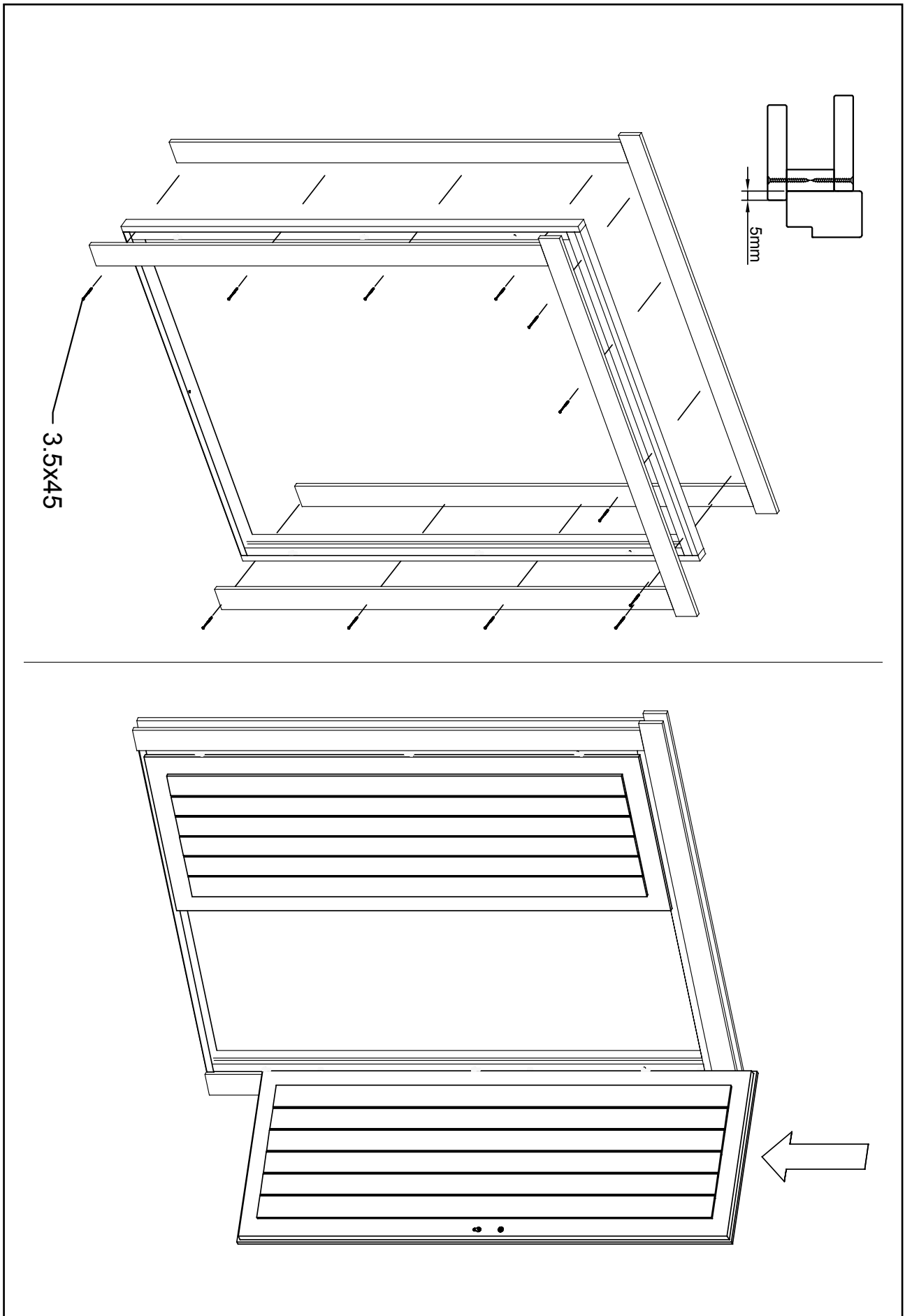

# Türmontage 536150

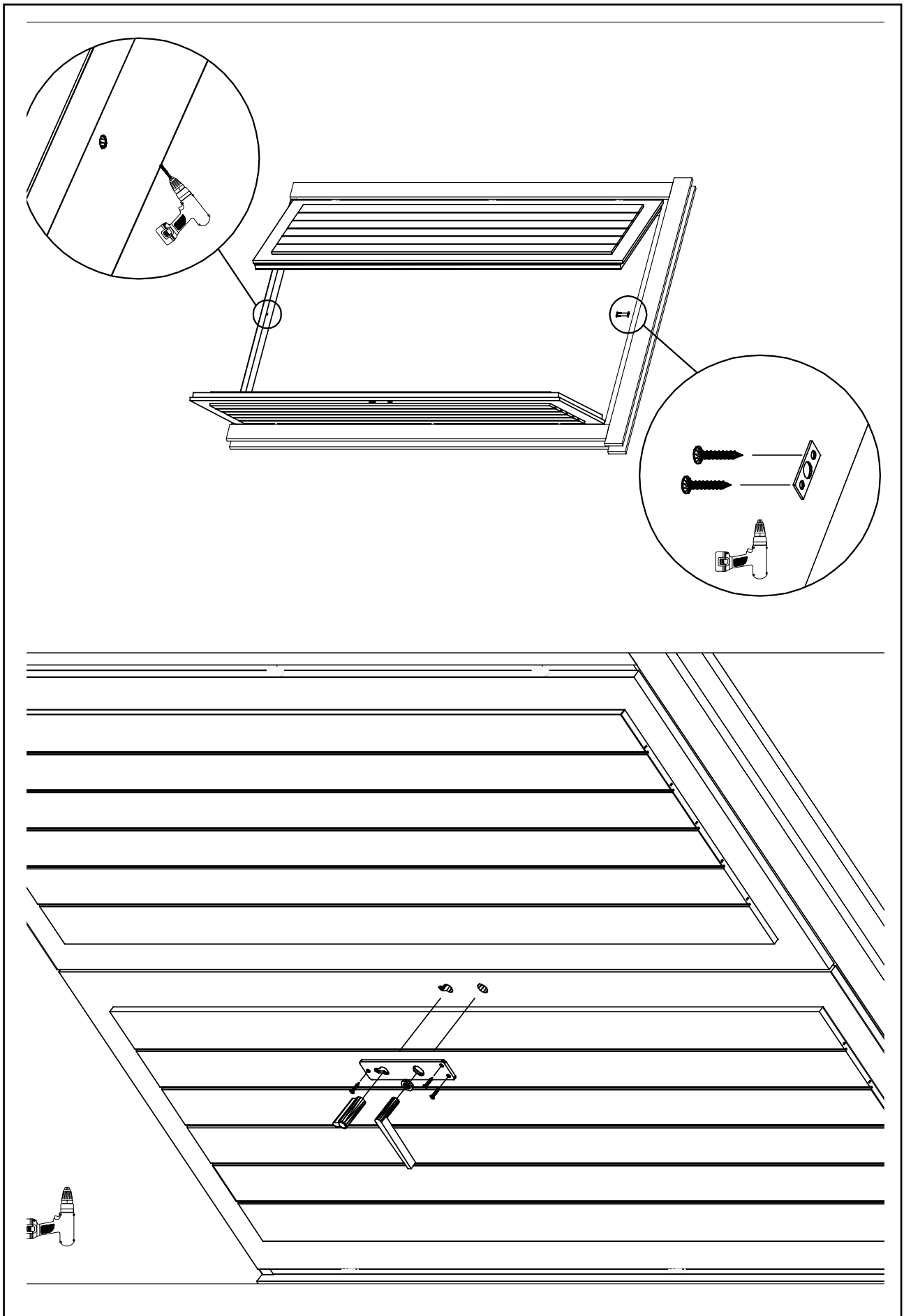

# Detailansicht Dach

## 536150

