

Technische Daten: Art.-Nr.: 537100

Wandaußenmaß: 299 x 299 cm

Bohlenstärke: 40 mm



Kontrolliert durch:

Empty rectangular box for signature or stamp.

Achtung: Alle angegebenen Maße sind ca.-Maße!

3D-Darstellung und Grundriss 537100

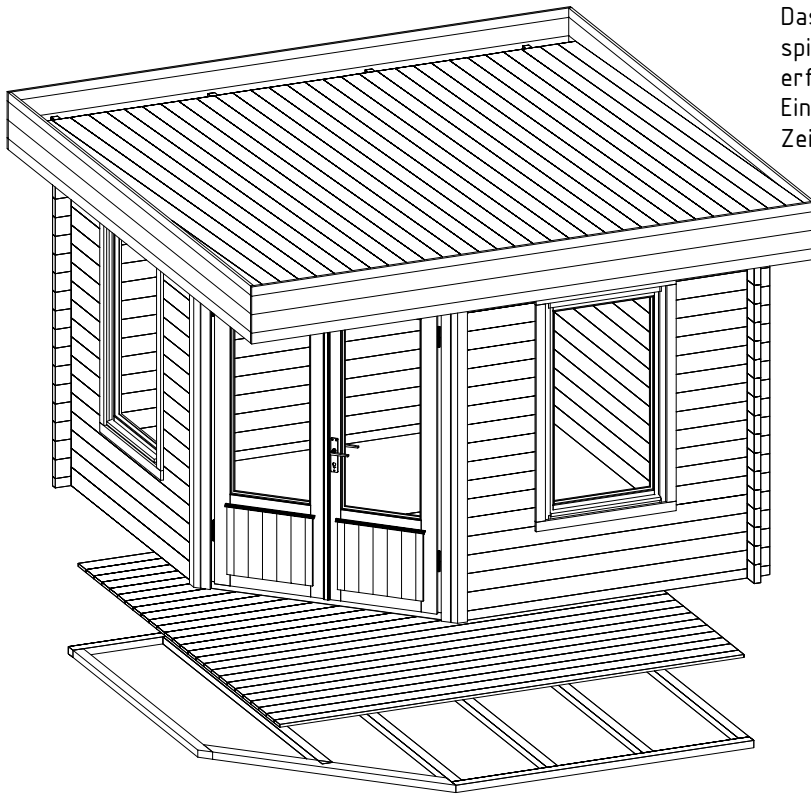

Das Haus Maja A lässt sich auch spiegelverkehrt aufbauen. Darum ist es erforderlich, die Fussbodenbretter im Eingangsbereich laut beigefügter Zeichnung selbst zuzuschneiden.

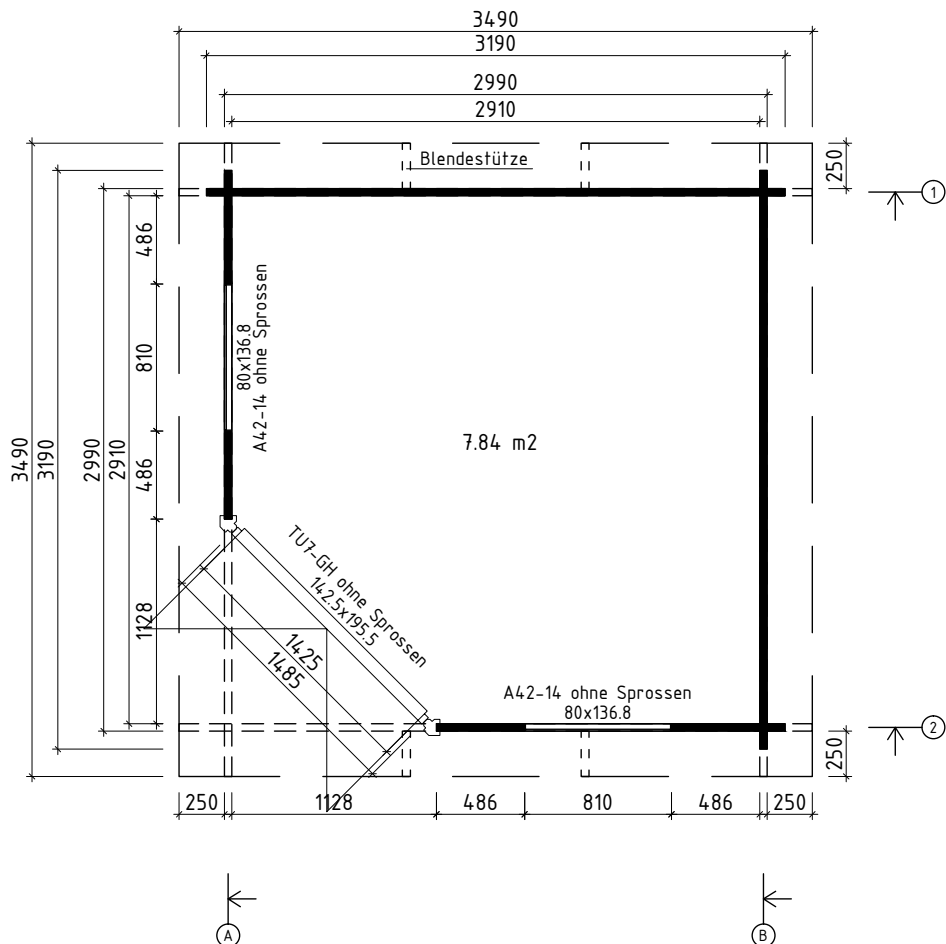











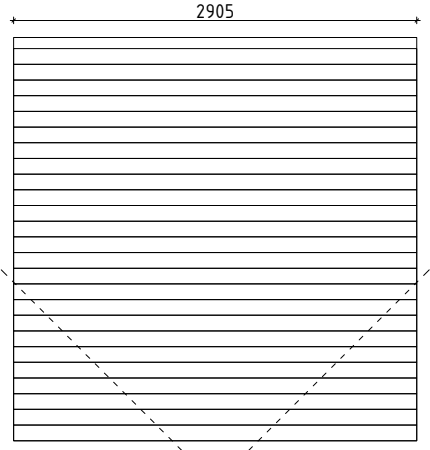





Teilleiste 1

537100

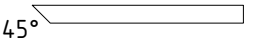
Pos		Stck.	Profil (mm)	Länge (mm)
001		1	40x48	3490
002		1	40x114	3490
003		1	40x57	3490
004		1	40x114	3490
005		2	40x114	3340
006		2	40x114	3200
007		1	40x114	3190
008		1	40x114	3190
009		35	40x114	3190
010		1	40x57	3190
011		1	40x114	1922
012		8	40x114	1922
013		1	40x57	1922
014		1	40x114	1922
015		24	40x114	626
016		24	40x114	456
FH6	 FUNDAMENTHÖLZER (imprägniert)	1	94x44	1595
FH4	 FUNDAMENTHÖLZER (imprägniert)	1	65x44	2990
FH3	 FUNDAMENTHÖLZER (imprägniert)	4	65x44	2860
FH2	 FUNDAMENTHÖLZER (imprägniert)	1	65x44	2294
FH1	 FUNDAMENTHÖLZER (imprägniert)	1	65x44	1864
FH5	 FUNDAMENTHÖLZER (imprägniert)	1	65x44	1864
LE1	 LEISTE	4	15x40	1358
DB1	 DACHBALKEN	3	44x145	3690
	DACHBRETTER	31+1	113x18	3395
	FUSSBODENLEISTE	✓	18x40	12,0 lfm
BL-1	DACHBLENDEN 350mm	2	18x350	3490
BL-2	DACHBLENDEN 350mm	2	18x350	3526
BS-1	DACHBLENDEN- Blendenstützen 44x65	4	44x65	250

Teilleiste 2

537100

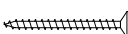
Pos			Stck	Profil (mm)	Länge (mm)	
	FUSSBODENBRETTER		✓	26+1	113x18	2905
	<p>Diese Haus lässt sich auch spiegelverkehrt aufbauen. Darum ist es erforderlich, die Fussbodenbretter im Eingangsbereich laut beigefügter Zeichnung selbst zuzuschneiden.</p> 					
UPB-1	DACHBLENDEN- U-Profil für Blenden		✓		65x44	15,0 lfm
DPL-1	DACHPAPPENLEISTE 15x28		✓		15x28	11,0 lfm
T4-1	TRAUFENLEISTE 40x18		✓		40x18	7,0 lfm
SM-1	Sturmleisten			2	40x18	2050
SM-2	Sturmleisten			2	40x18	2165
P9L-1	ECKTÜR- linke Türpfoste 90			1	90x90	2015
P9R-1	ECKTÜR- rechte Türpfoste 90			1	90x90	2015
DzT 40-1	ECKTÜR- Deckbrett zum Tür 40			1	18x40	1585
VK-1	ECKTÜR- Verkleidungsleisten für Vordachelement		✓	2	58x12	1110
VE1	ECKTÜR- Vordachelement 1435x745			1		
SH	Schlaghölzer			3		
SMS	Schlossschrauben M8x70 Mutter U-Scheibe			12	M8	
NG3	DACHPAPPNÄGEL 2.0x18			250		
NG1	NÄGEL 2.5x50	Dachbretter Fussbodenbretter		622		
SR01	SCHRAUBEN 3.0x30	Fussbodenleisten, Dachpappenleisten Traufleisten 40x18		59		
SR03	SCHRAUBEN 3.5x45	U-Profil, LE1, Deckbrett Vordachelement, Verkleidungsleisten		116		

Zuschnitt Fussboden 537100

Zuschneiden der Fussbodenbretter 113x18mm

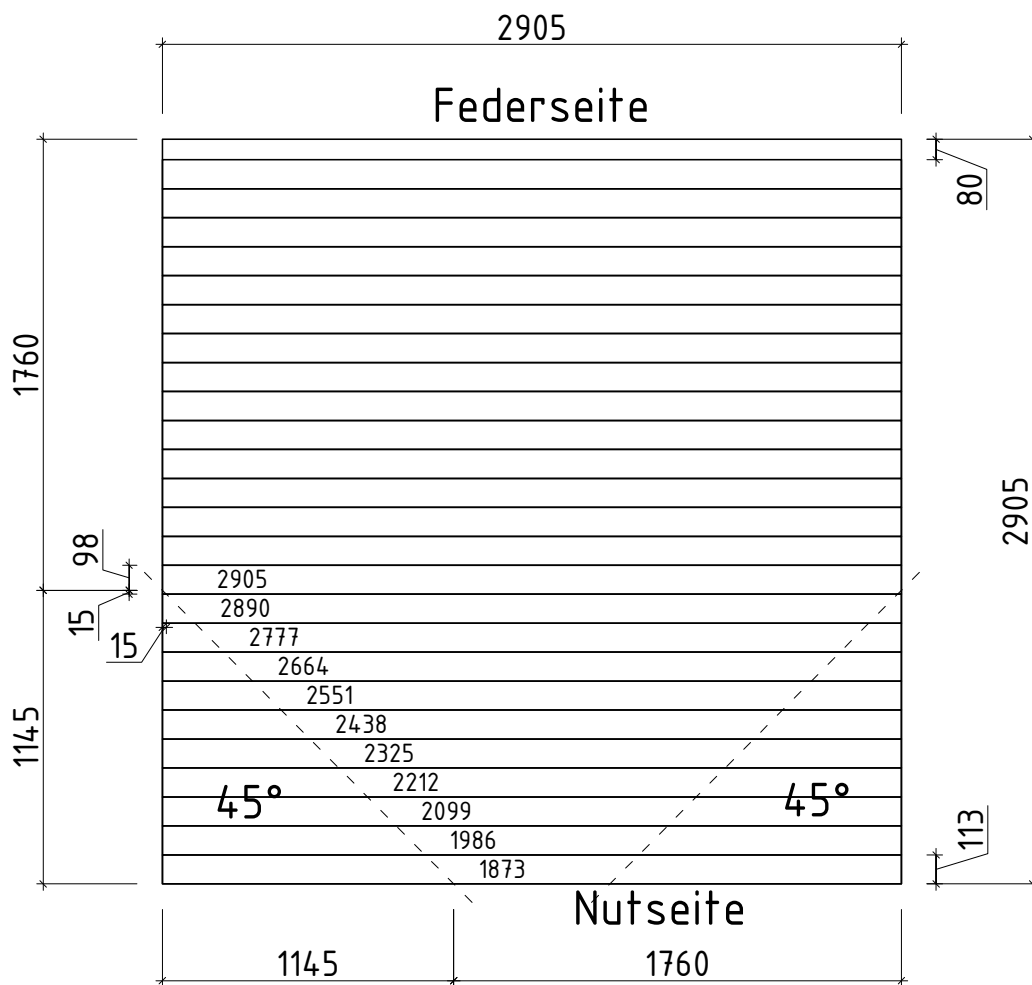

Wandplan 1 und 2 537100

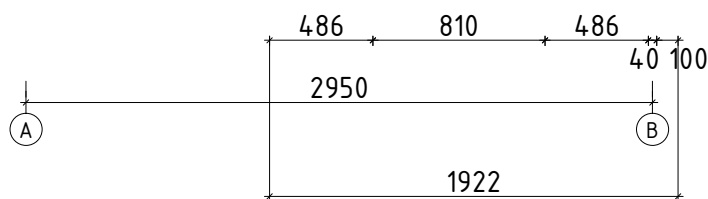
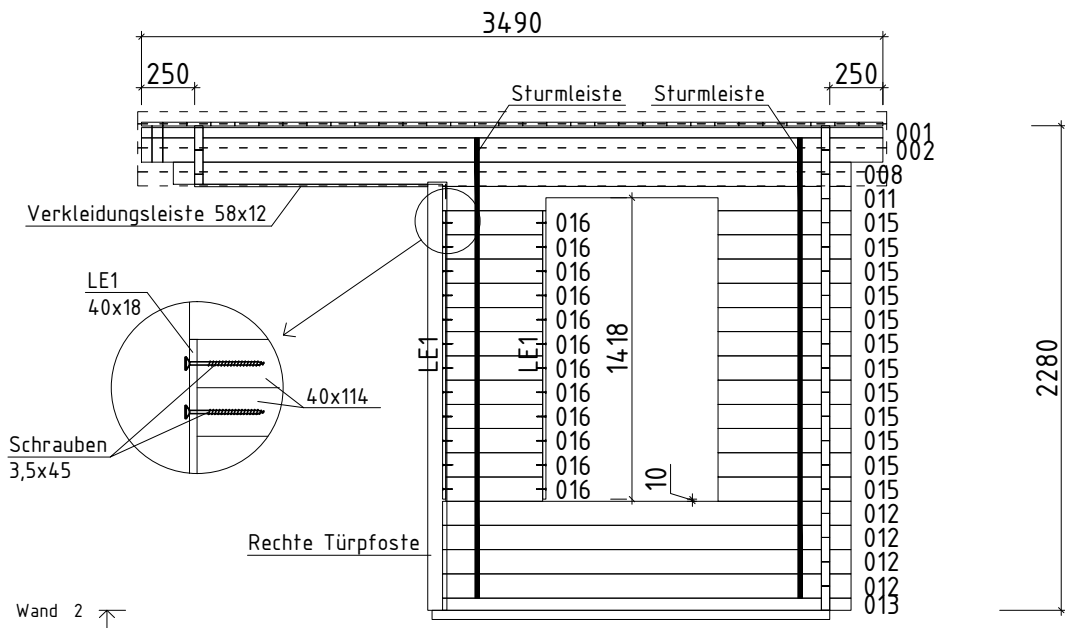
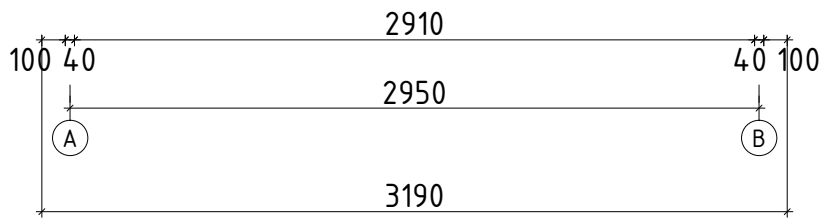
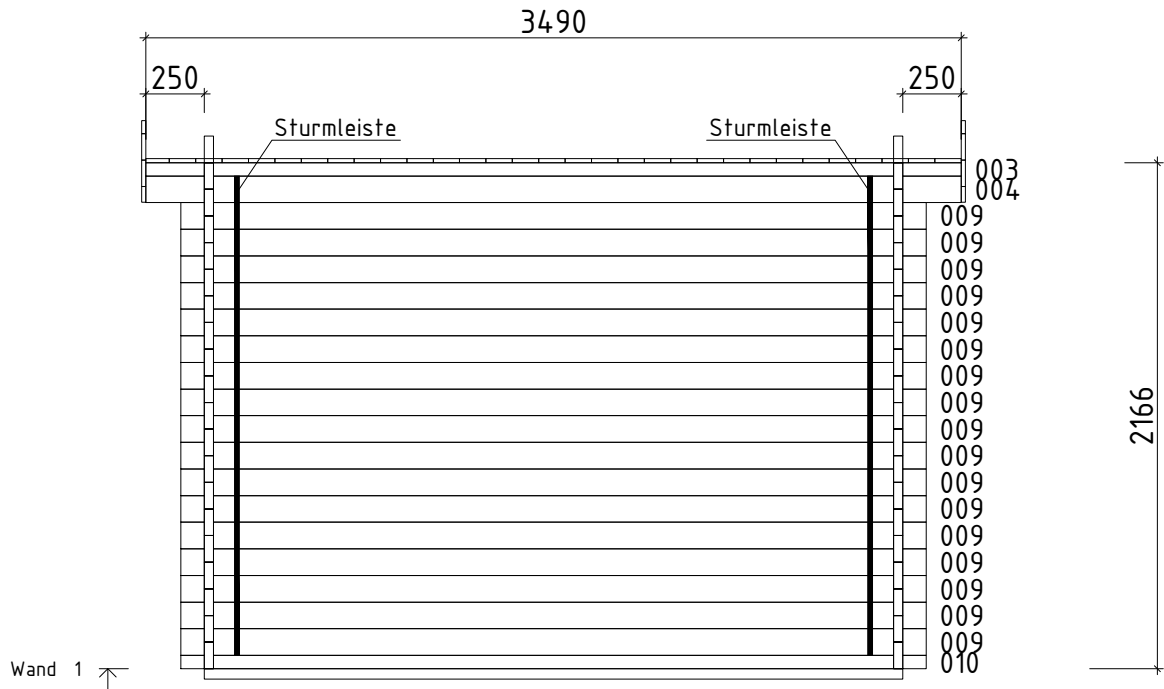

Detailansicht 537100

Die Dachbalken bei der Maja A sind länger als der Dachüberstand, damit das Seitendach als Zubehör montiert werden kann.

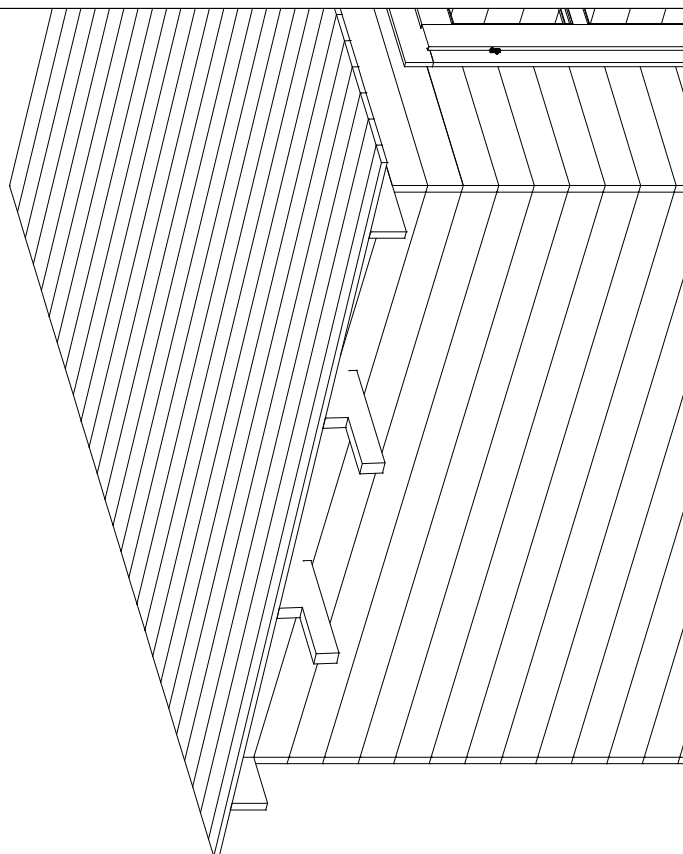

Falls kein Zubehör am Dach montiert werden soll, bitte die Enden der Dachbalken wie gezeigt absägen.

