

Technische Daten: Art.-Nr.: 350160

Wandaußenmaß: 720 x 320 cm

Bohlenstärke: 70 mm



Kontrolliert durch:

Empty rectangular box for signature or name.

Achtung: Alle angegebenen Maße sind ca.-Maße!

3D-Darstellung 350160

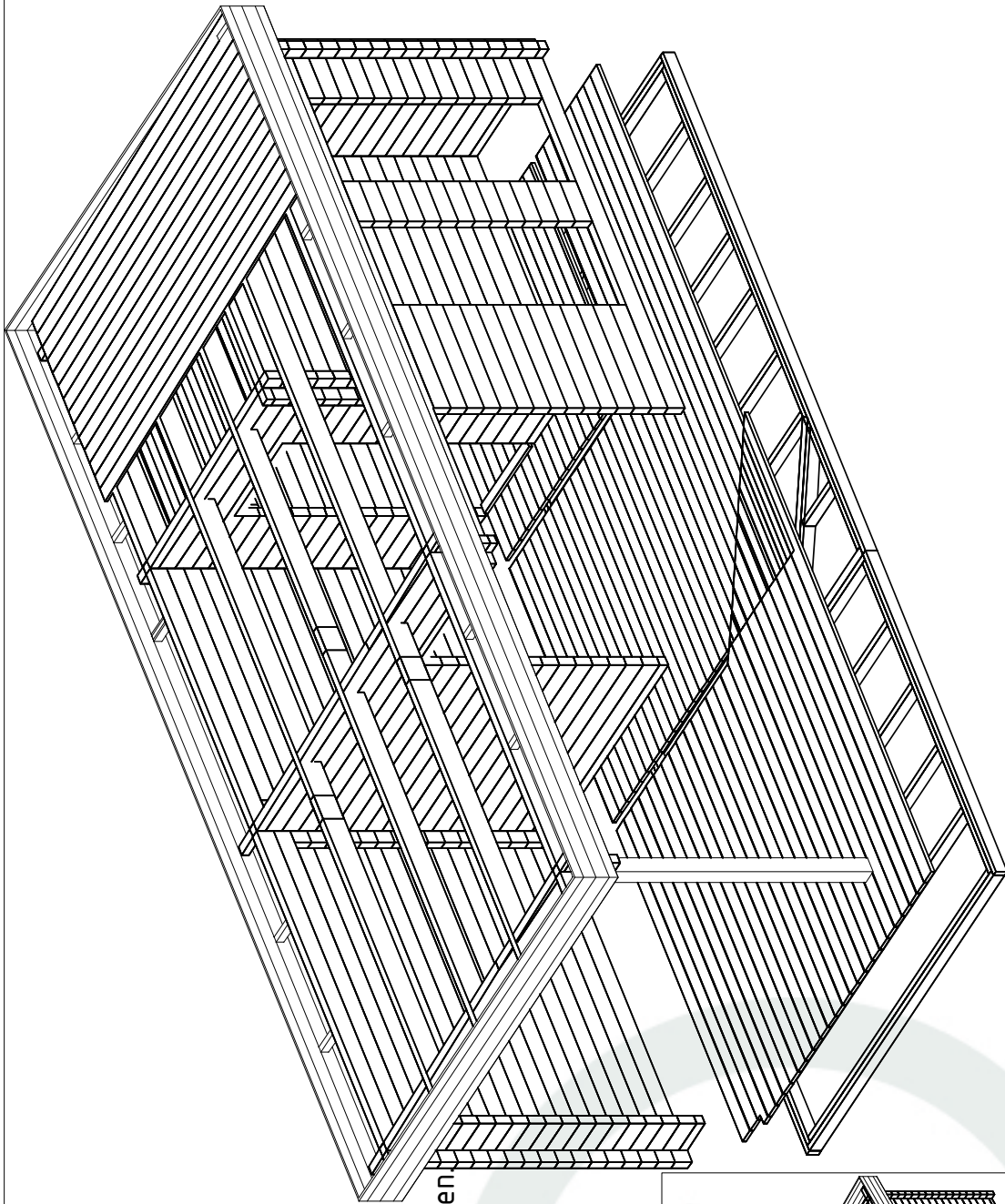

Das Haus Sauna Yurika lässt sich auch spiegelverkehrt aufbauen. Darum ist es erforderlich, die Fussbodenbretter und Terrassenbretter im Eingangsbereich laut beigefügter Zeichnung selbst zuzuschneiden.

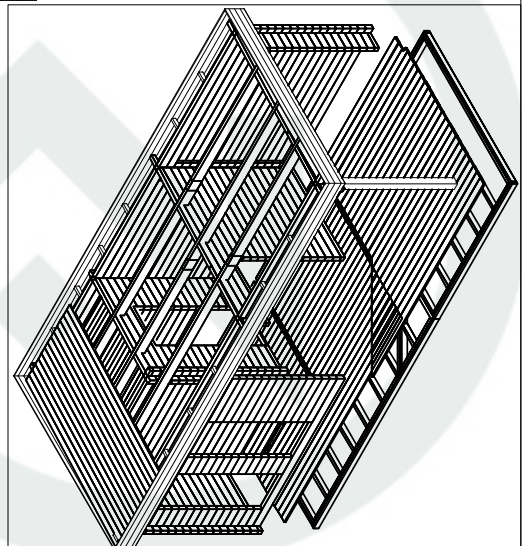

Grundriss 350160

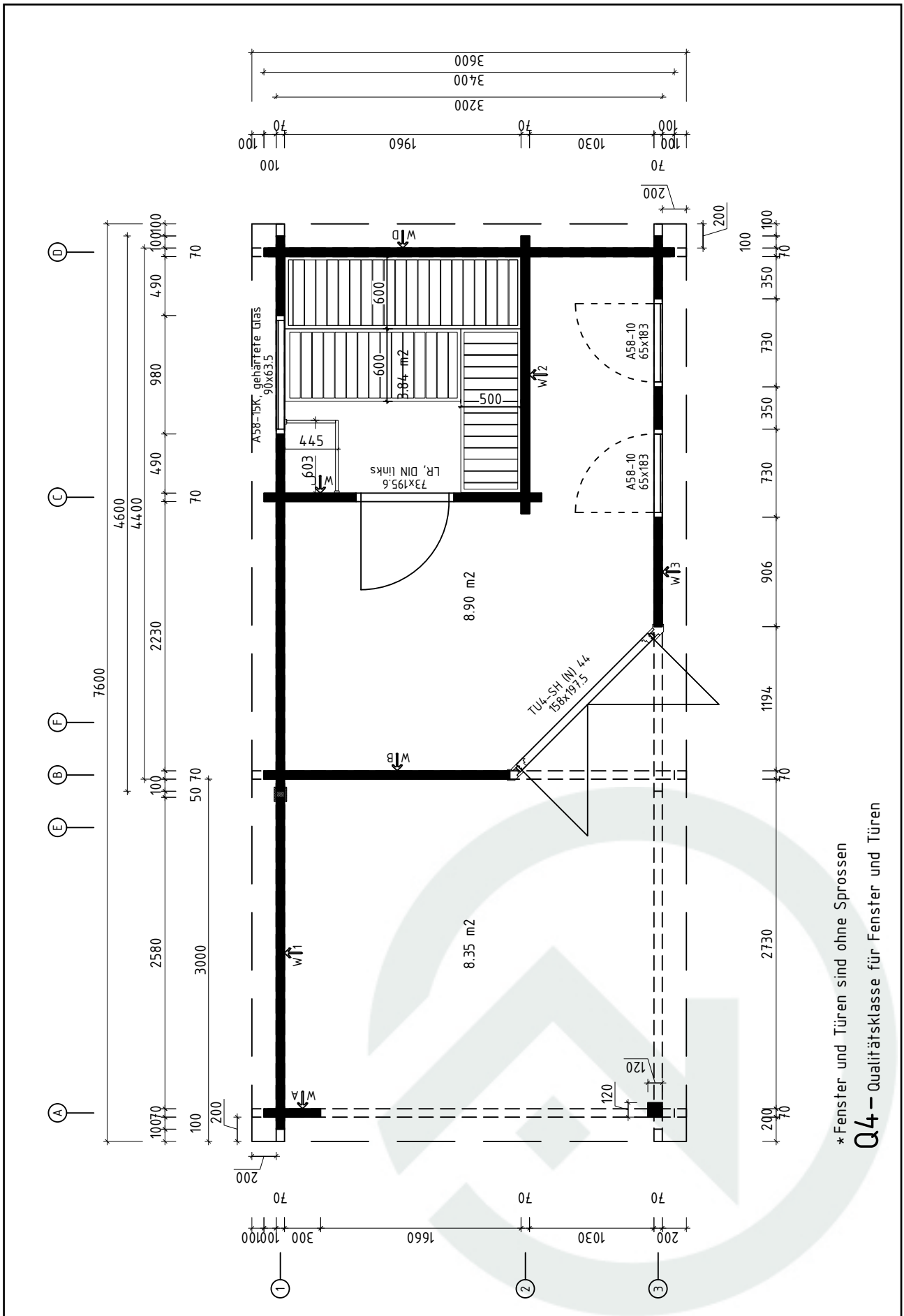

* Fenster und Türen sind ohne Sprossen
Q4 - Qualitätsklasse für Fenster und Türen

Grundriss 350160

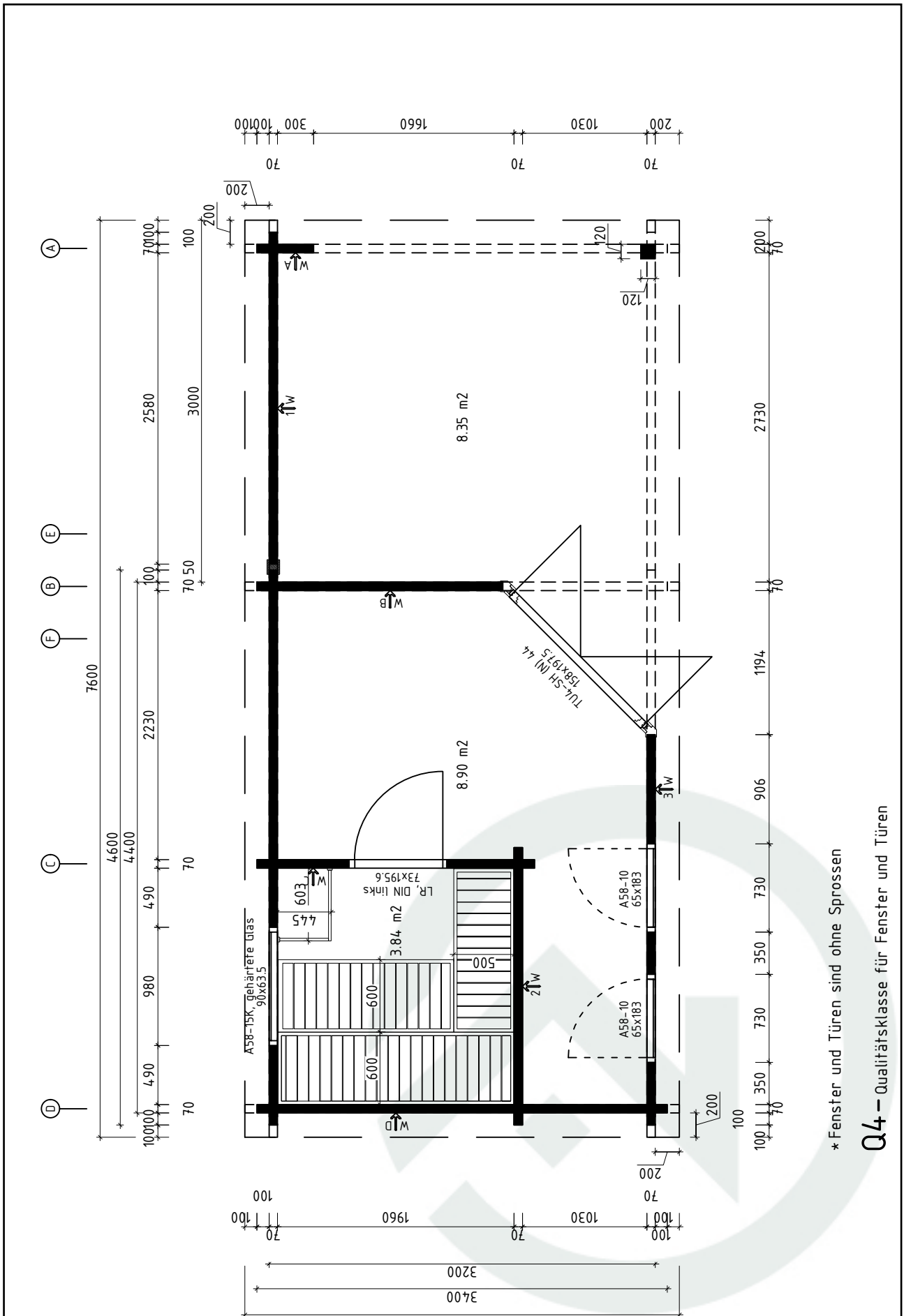

* Fenster und Türen sind ohne Sprossen

Q4 – Qualitätsklasse für Fenster und Türen

Lagerholzplan und Fundamentplan 350160

**Wir empfehlen als Fundament für Ihr Gartenhaus eine vollflächig festgegründete, gepflasterte oder betonierte Fläche.
Wahlweise ist auch ein Punkt- oder Streifenfundament möglich.**

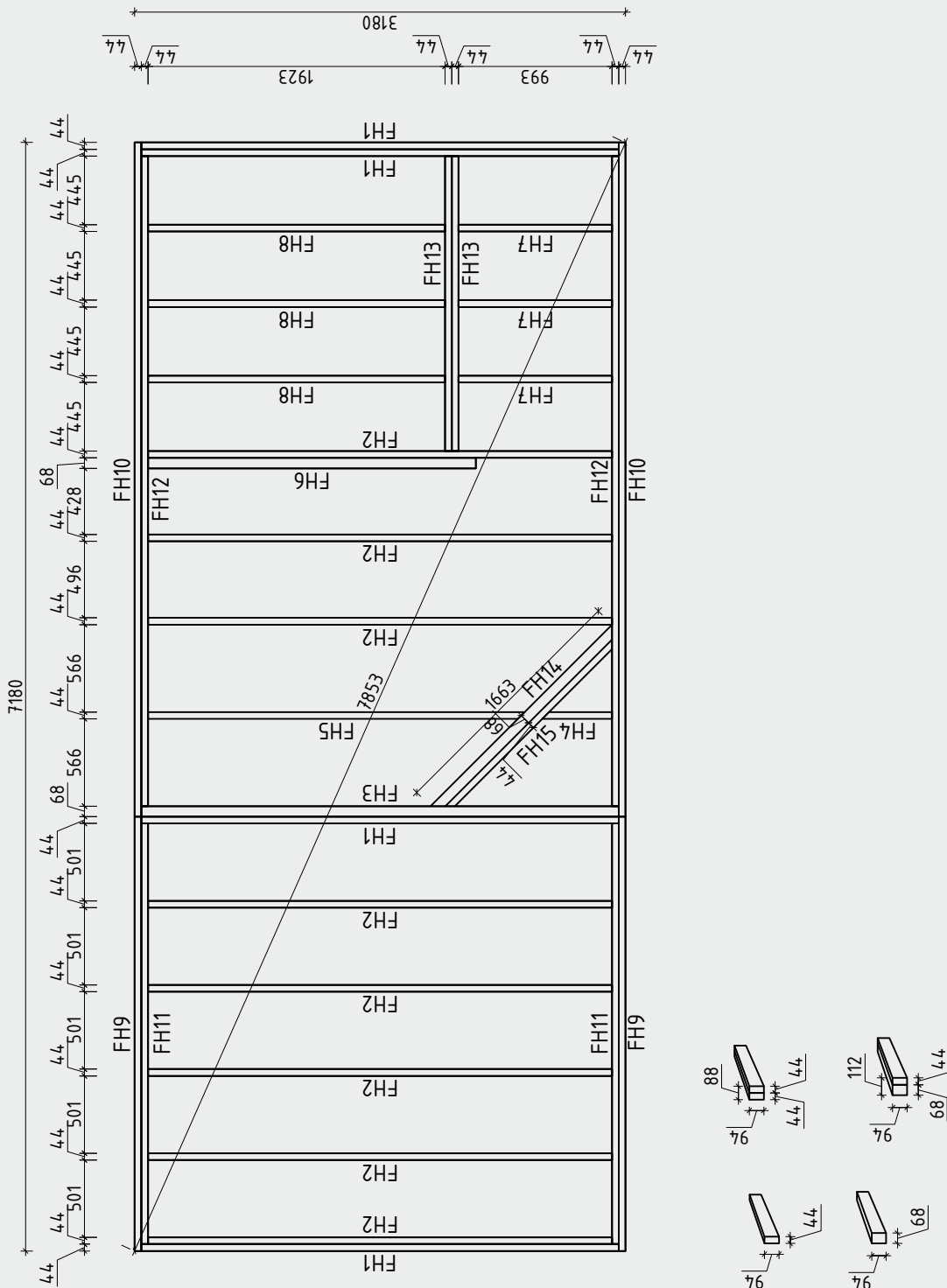

Lagerholzplan und Fundamentplan 350160

**Wir empfehlen als Fundament für Ihr Gartenhaus eine vollflächig festgegründete, gepflasterte oder betonierte Fläche.
Wahlweise ist auch ein Punkt- oder Streifenfundament möglich.**

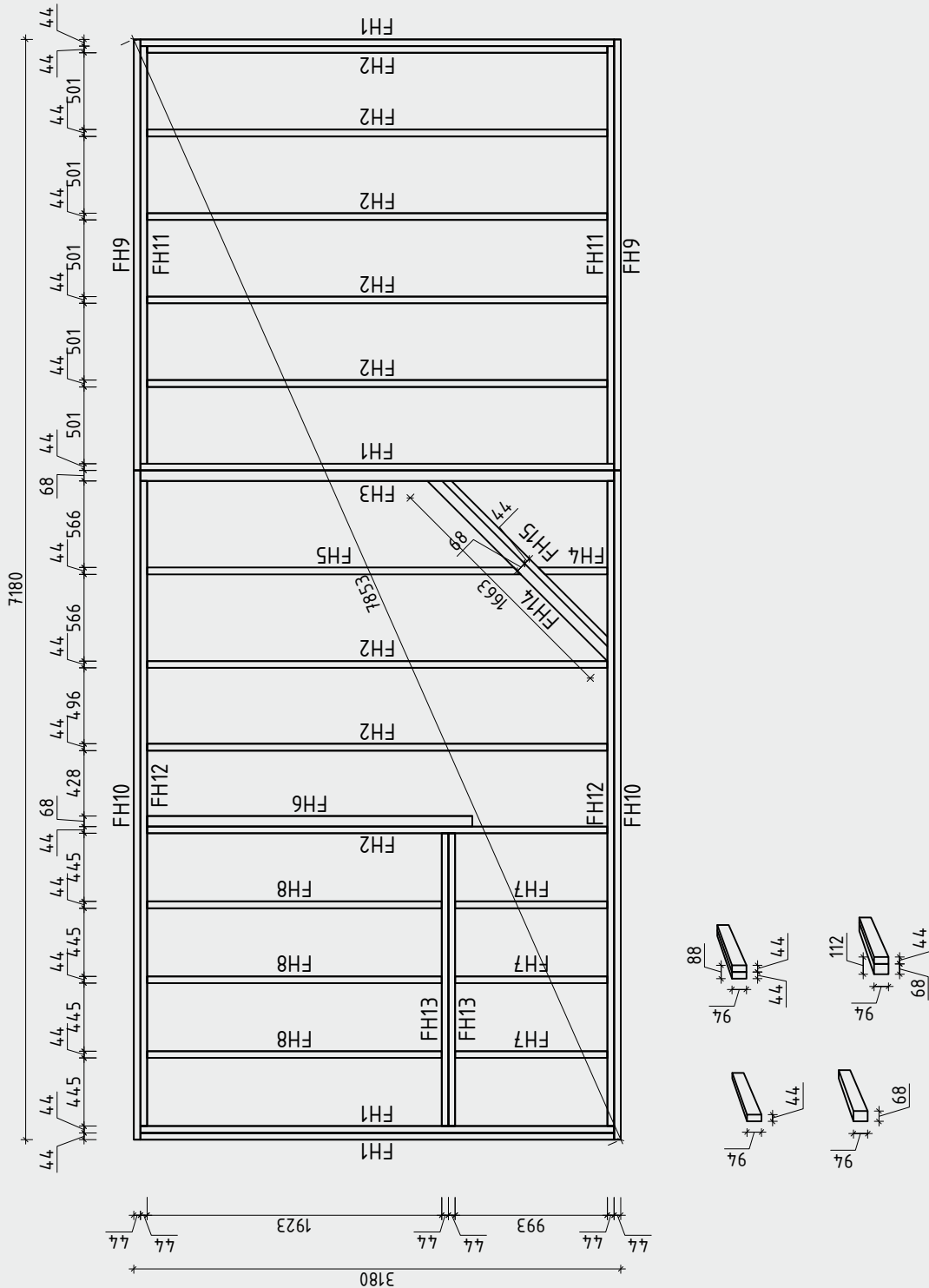

Teileliste 1

350160

Pos		Stck.	Profil (mm)	Länge (mm)
001		1	70x135	5235
002		1	70x135	4617
003		1	70x135	4600
004		1	70x135	4600
005		9	70x135	4600
006		1	70x135	4600
007		1	70x135	4565
008		1	70x104	4565
009		1	70x135	4465
010		1	70x135	3600
011		2	70x135	3600
012		15	70x135	3400
013		2	70x135	3400
014		1	70x68	3400
015		1	70x135	3400
016		3	70x135	3400
017		1	70x135	3400
018		1	70x135	3236
019		1	70x104	3035
020		1	70x135	3035
021		5	70x135	2960
022		1	70x135	2935
023		1	70x135	2783
024		16	70x135	2750
025		1	70x135	2300











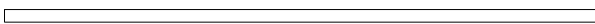
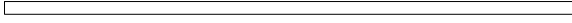
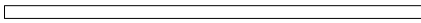
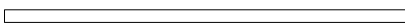





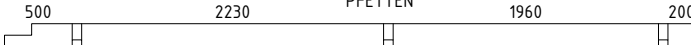
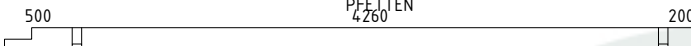

Teileliste 2

350160

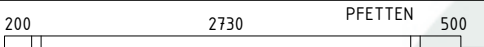
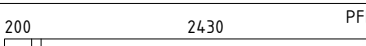
Pos		Stck.	Profil (mm)	Länge (mm)
026		1	70x68	2300
027		20	70x135	2300
028		1	70x135	2300
029		1	70x135	2165
030		14	70x135	2036
031		1	70x68	2036
032		3	70x43	1300
033		7	70x135	906
034		4	70x135	906
035		3	70x135	906
036		1	70x68	763
037		14	70x135	763
038		1	70x68	728
039		14	70x135	728
040		5	70x135	660
041		14	70x135	520
042		8	70x135	470
043		4	70x135	470
044		3	70x135	470
045		1	70x68	470
046		10	70x135	350
047		4	70x135	350
FH3	FUNDAMENTHÖLZER (imprägniert) 	1	68x94	3092
FH6	FUNDAMENTHÖLZER (imprägniert) 	1	68x94	2122
FH14	FUNDAMENTHÖLZER (imprägniert) 45° 45°	1	68x94	1663



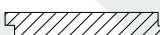
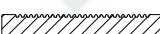
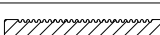







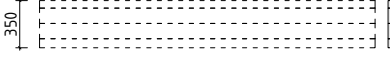
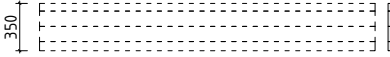
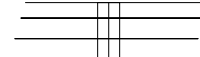







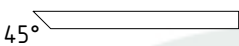

Teileliste 3

350160

Pos		Stck	Profil (mm)	Länge (mm)
FH10	FUNDAMENTHÖLZER (imprägniert) 	2	44x94	4367
FH12	FUNDAMENTHÖLZER (imprägniert) 	2	44x94	4211
FH1	FUNDAMENTHÖLZER (imprägniert) 	4	44x94	3092
FH2	FUNDAMENTHÖLZER (imprägniert) 	8	44x94	3004
FH9	FUNDAMENTHÖLZER (imprägniert) 	2	44x94	2813
FH11	FUNDAMENTHÖLZER (imprägniert) 	2	44x94	2725
FH5	FUNDAMENTHÖLZER (imprägniert) 45° 	1	44x94	2438
FH8	FUNDAMENTHÖLZER (imprägniert) 	3	44x94	1923
FH13	FUNDAMENTHÖLZER (imprägniert) 	2	44x94	1911
FH15	FUNDAMENTHÖLZER (imprägniert) 45°  45°	1	44x94	1527
FH7	FUNDAMENTHÖLZER (imprägniert) 	3	44x94	993
FH4	FUNDAMENTHÖLZER (imprägniert) 45° 	1	44x94	452
HS1	HOLZSCHWELLE (unter der Saunatur) 	✓ 1	75x28	750
PF2	500 2230 PFETTEN 1960 200 	1	58x170	5100
PF5	500 PFETTEN 4260 200 	1	58x170	5100
PF4	1930 PFETTEN 1960 200 	1	58x170	4230
PF3	200 2730 PFETTEN 500 	1	58x170	3570
PF1	200 2430 PFETTEN 	2	58x170	2700
	DACHBRETTER 	68+1	113x18	3500
	FUSSBODENBRETTER  ✓	10+1	113x28	4255
	FUSSBODENBRETTER 	18	113x28	2225
	FUSSBODENBRETTER 	18	113x28	1955
	TERRASSENBRETTER (imprägniert)  ✓	10+1	120x28	2904-4029
	TERRASSENBRETTER (imprägniert) 	15	120x28	2795
	ABDECKLEISTEN  ✓		15x28	23.0lfm



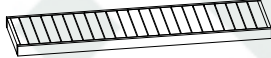
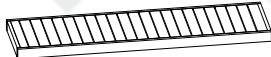
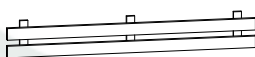







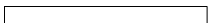



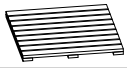

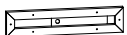

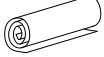
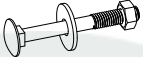

Teileliste 4

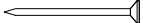
350160

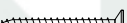
Pos		Stck	Profil (mm)	Länge (mm)
	FUSSBODENLEISTEN  ✓		14x55	23.0lfm
BL-1	DACHBLENDEN 350mm 	2	18x350	3600
BL-2	DACHBLENDEN 350mm 	4	18x350	3818
VL-1	DACHBLENDEN- Verbindungsleisten 	2	18x120	350
BS-1	DACHBLENDEN- Blendenstützen 44x65 	12	44x65	200
UPB-1	DACHBLENDEN- U-Profil für Blenden  40 ✓		65x44	23.0lfm
DPL-1	DACHPAPPENLEISTEN 15x28  ✓		15x28	15.0lfm
T06-1	TRAUFENLEISTEN 18x40  ✓		18x40	15.5lfm
A70-1	ADAPTER 70  Obere seite  150 ✓	1	120x106	2260
TP1 20-1	STÜTZPFOSTEN 120x120  67.5 ✓	1	120x120	2090
TL70-1	T-LEISTE 70 	2	45x70	625
TL7 0-2	T-LEISTE 70 	4	45x70	1840
TL7 0-3	T-LEISTE 70 	2	45x70	1910
DzT 58-1	ECKTÜR- Deckbrett zum Tür 58 	1	18x58	1750
VK3-1	ECKTÜR- Verkleidungsleisten 95 für Vordachelement  45° ✓	2	95x18	1250
P9L4-1	ECKTÜR- linke Türpfoste 70  40	1	90x90	2035
P9R 4-1	ECKTÜR- rechte Türpfoste 70  40	1	90x90	2035
VE3	ECKTÜR- Vordachelement 1600x825 	1		
	DECKENISOLATION  	2 Elemente		ca 1950x975
SA0 2-1	SAUNA - Saunabank 50cm 	1	500x90	1355
SA01-1	SAUNA - Saunabank 60cm 	2	600x90	1955
SA16-1	SAUNA - Bänke Zwischenstück 	1	40x300	1955
SA15-1	SAUNA - Rücklehne 	2	40x250	1860



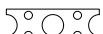













Teileliste 5

350160

Pos			Stck	Profil (mm)	Länge (mm)	
SA11-1	SAUNA - Stützpfeosten für Saunabänke		✓	1	44x65	500
SA11-2	SAUNA - Stützpfeosten für Saunabänke		✓	2	44x65	1000
SA10-1	SAUNA - Trägeleiste für Saunabänke		✓	1	30x40	500
SA10-2	SAUNA - Trägeleiste für Saunabänke		✓	2	30x40	600
SA10-3	SAUNA - Trägeleiste für Saunabänke		✓	2	30x40	1200
SA20-1	SAUNA - Trägeleiste für Deckenisolation		✓	4	35x35	2010
SA37	SAUNA - Bodenrost			1		
SA30	SAUNA - Heizung Umbau (set 1)			1		
SA35	SAUNA - Kopfstütze			2		
SA36	SAUNA - Luftschieber			3		
SA25-1	SAUNA - Dichtungsband für Deckenisolationselemente		✓			8.0lfm
HK2	HOLZ-KLOTZEN für verbinden der Wandbohlen (122mm)			1		
SH	Schlaghölzer			3		
KP-1	DACHPAPPE		✓		8.3m-5'st	45.0lfm
SS14	Schloßschrauben M8x70 Mutter M8 U-Scheibe Ø25 - Befestigung für Saunabänke			2		
NG01	DACHPAPPNÄGEL 2.8x15			560		
NG04	NÄGEL 2.5x50 Dachbretter			680		
NG05	NÄGEL 2.5x60 Terrassenbretter Fußbodenbretter Holzschwelle			897		
SR32	SCHRAUBEN 3.0x30 Abdeckleisten, Fußbodenleisten, Verbindungsleisten Dachpappenleisten, Traufenleisten 40x18 Bänke Zwischenstück, Luftschieber			191		
SR37	SCHRAUBEN 3.5x45 U-Profil, Heizung Umbau, Verbindungsstreifen Türleisten: siehe Spezifikation für Fenster und Türen			200		
SR44	SCHRAUBEN 4.0x60 Trägeleiste für Saunabänke Trägeleiste für Deckenisolation, Rücklehne			61		
SR57	SCHRAUBEN 5.0x100 Fundamenthölzer Stützpfeosten 120x120			145		
SR55	SCHRAUBEN 5.0x70 Blendenbefestigung, Blendenstützen Verstellbare Pfeostenstütze Stützpfeosten für Saunabänke			98		
VS	VERBINDUNGSSTREIFEN für verbinden der Wandbohlen			4		
VP3	Verstellbare Pfeostenstütze M20			1		

Teileliste 6

350160

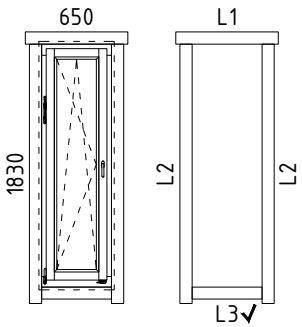
Pos		Stck.	Profil (mm)	Länge (mm)
KL-1	Gewindestange M12 - für die Pfetten 	6		170
MUT26	Mutter M12 U-Scheibe Ø30 - für die Pfetten 	12		
ML1	Metallstange 	1	D10	1040
ML2	Metallstange 	1	D10	970
ML3	Metallstange 	5	D10	900
ML4	Metallstange 	2	D10	770
ML5	Metallstange 	5	D10	360
ML6	Metallstange 	1	D10	330
KL1	Gewindestange M8 	3		2000
KL2	Gewindestange M8 	1		564
KL3	Gewindestange M8 	1		509
KL4	Gewindestange M8 	2		460
KL5	Gewindestange M8 	1		374
	Mutter M8 	10		
	U-Scheibe M8 Ø25 	10		
	Befestigungsmutter M8 	3		
	FENSTER 650x1830  <p>A58-10 spez</p> <p>L1 18x90 L=850mm 2* L2 18x90 L=1910mm 4* L3 18x90 L=610mm 2* ✓</p> <p>1x DIN links / 1x DIN rechts</p>	2		

Teileliste 7

350160

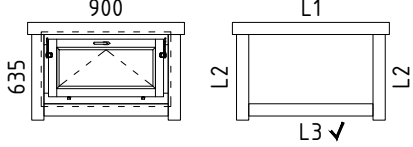
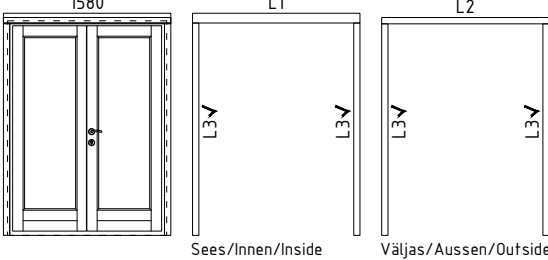
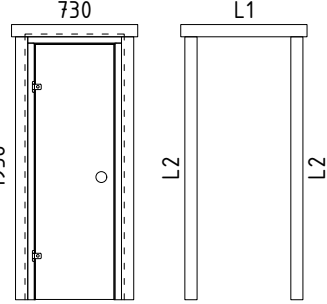
Pos		Stck	Profil (mm)	Länge (mm)												
	<p>FENSTER 900x635</p>  <p>A58-15K, spez, gehärtete Glas</p> <table> <tr> <td>L1</td> <td>18x90</td> <td>L=1100mm</td> <td>2*</td> </tr> <tr> <td>L2</td> <td>18x90</td> <td>L=715mm</td> <td>4*</td> </tr> <tr> <td>L3</td> <td>18x90</td> <td>L=860mm</td> <td>2* ✓</td> </tr> </table>	L1	18x90	L=1100mm	2*	L2	18x90	L=715mm	4*	L3	18x90	L=860mm	2* ✓	1		
L1	18x90	L=1100mm	2*													
L2	18x90	L=715mm	4*													
L3	18x90	L=860mm	2* ✓													
TU4-SH nurk70	<p>TÜR 1580x1975</p>  <p>TU4-SH spez (nurk)</p> <table> <tr> <td>L1</td> <td>18x120</td> <td>L=1656mm</td> <td>1*</td> </tr> <tr> <td>L2</td> <td>18x40</td> <td>L=1656mm</td> <td>1*</td> </tr> <tr> <td>L3</td> <td>18x58</td> <td>L=1955mm</td> <td>4* ✓</td> </tr> </table> <p>DIN rechts</p> <p>Sees/Innen/Inside Väljas/Aussen/Outside</p>	L1	18x120	L=1656mm	1*	L2	18x40	L=1656mm	1*	L3	18x58	L=1955mm	4* ✓	1		
L1	18x120	L=1656mm	1*													
L2	18x40	L=1656mm	1*													
L3	18x58	L=1955mm	4* ✓													
	<p>TÜR 730x1956</p>  <p>LR</p> <table> <tr> <td>L1</td> <td>18x90</td> <td>L=930mm</td> <td>2 Stck.</td> </tr> <tr> <td>L2</td> <td>18x90</td> <td>L=1935mm</td> <td>4 Stck. ✓</td> </tr> </table> <p>DIN links</p>	L1	18x90	L=930mm	2 Stck.	L2	18x90	L=1935mm	4 Stck. ✓	1						
L1	18x90	L=930mm	2 Stck.													
L2	18x90	L=1935mm	4 Stck. ✓													
<p style="text-align: center;">Achtung Hinweis: wir empfehlen die Stromverkabelung für den Elektro-Saunaofen <u>vor</u> Verlegung von den Fußbodenbrettern durchzuführen.</p>																
	✓	- bitte selber anpassen (falls nötig)!														

Wandplan 1 350160

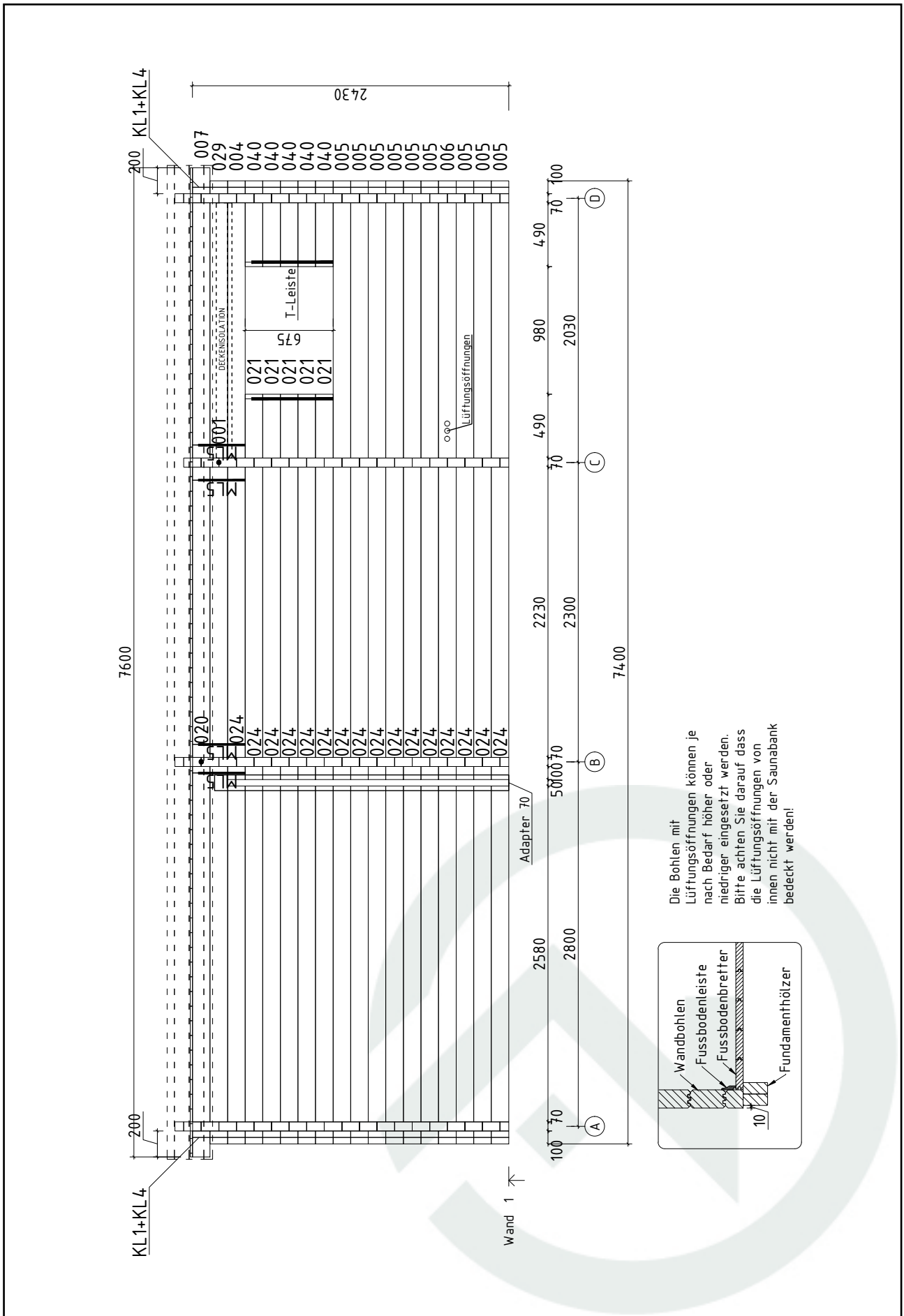

Wandplan 2 und 3 350160

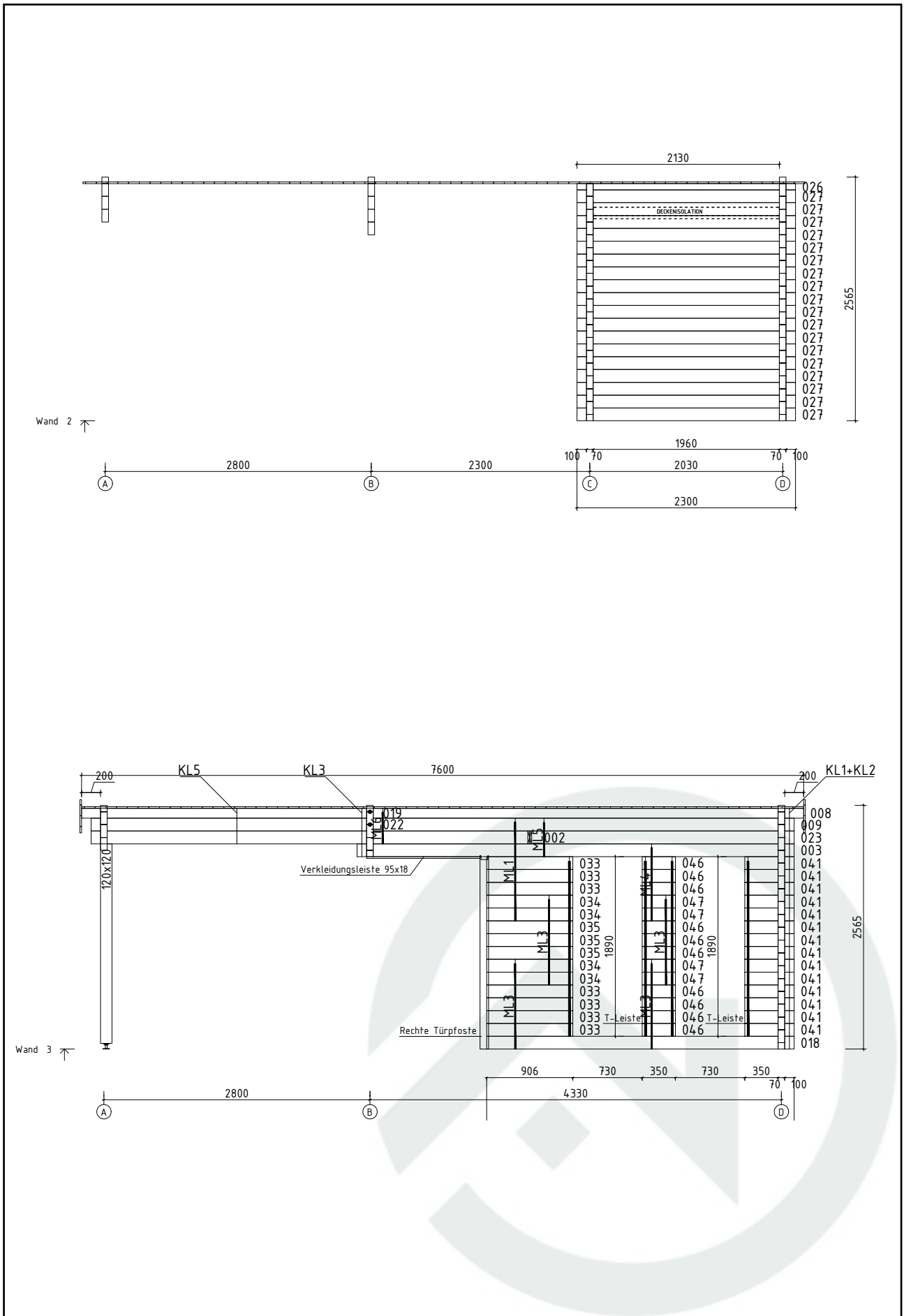

Wandplan A und B 350160

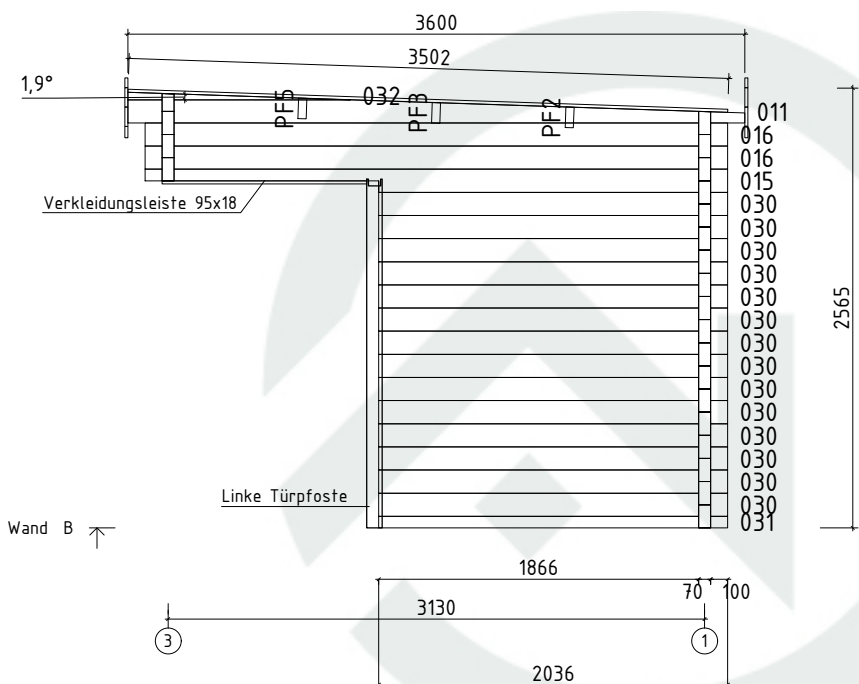
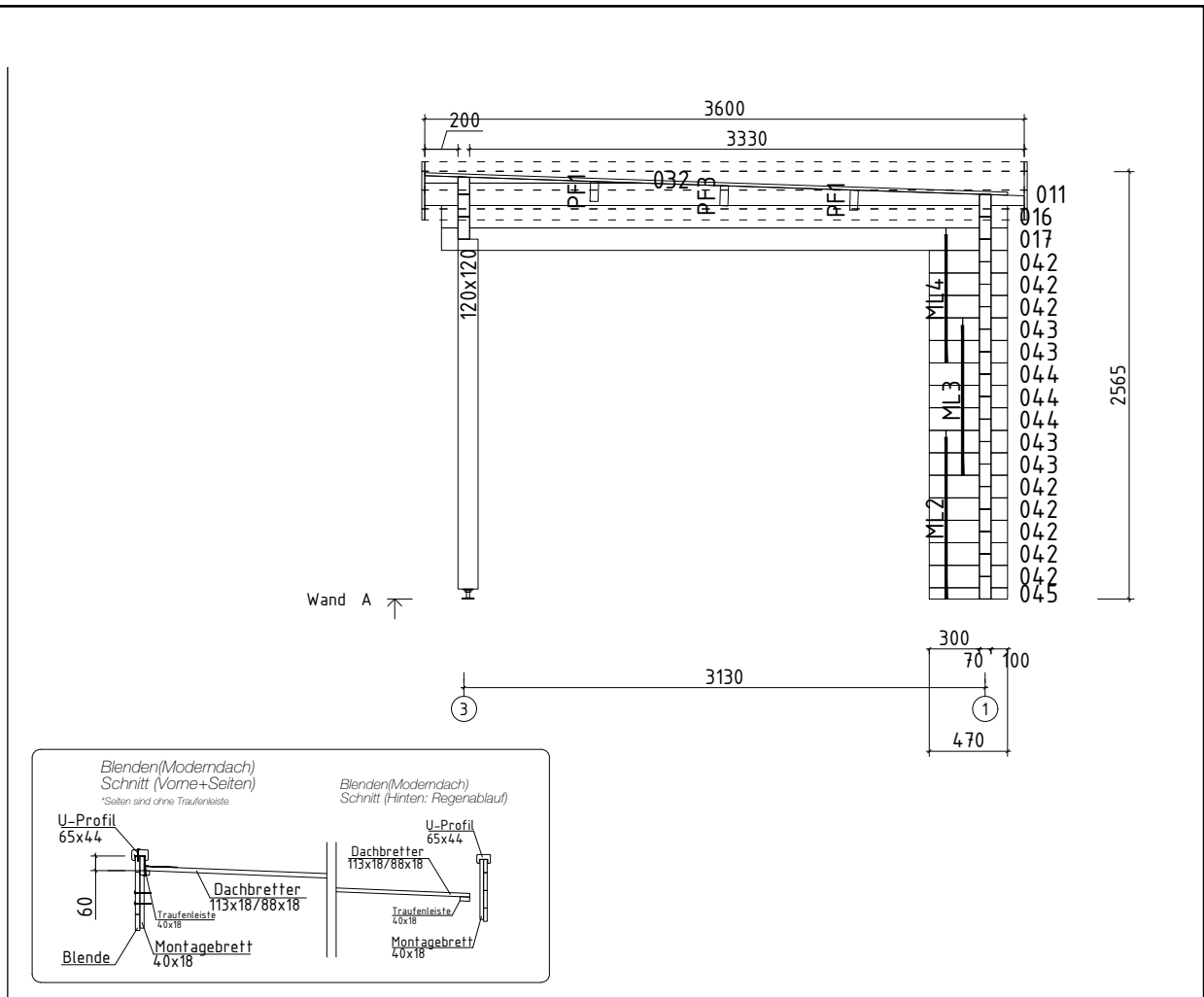

Wandplan C und D 350160

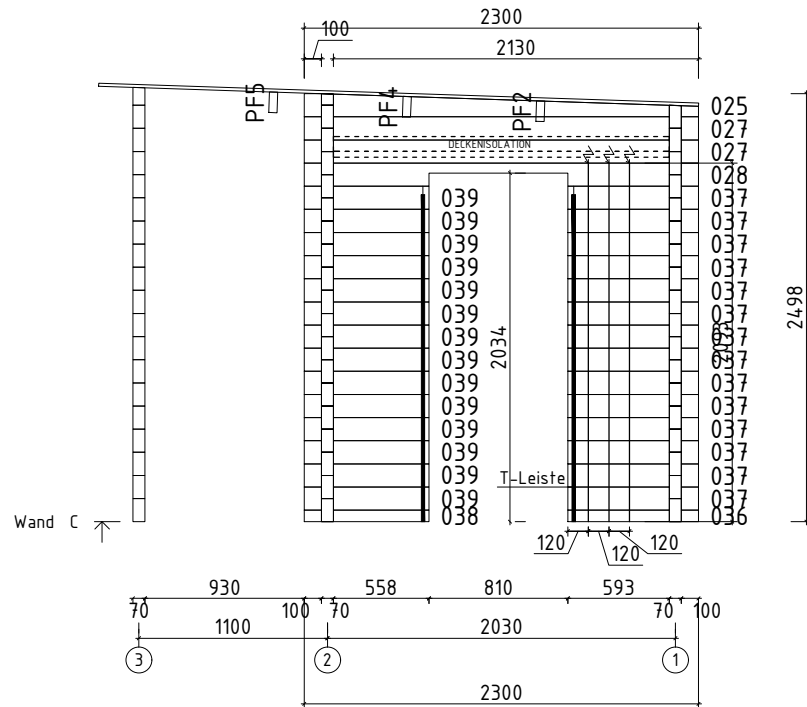

↘ -Bohrung für elektrische Kabel

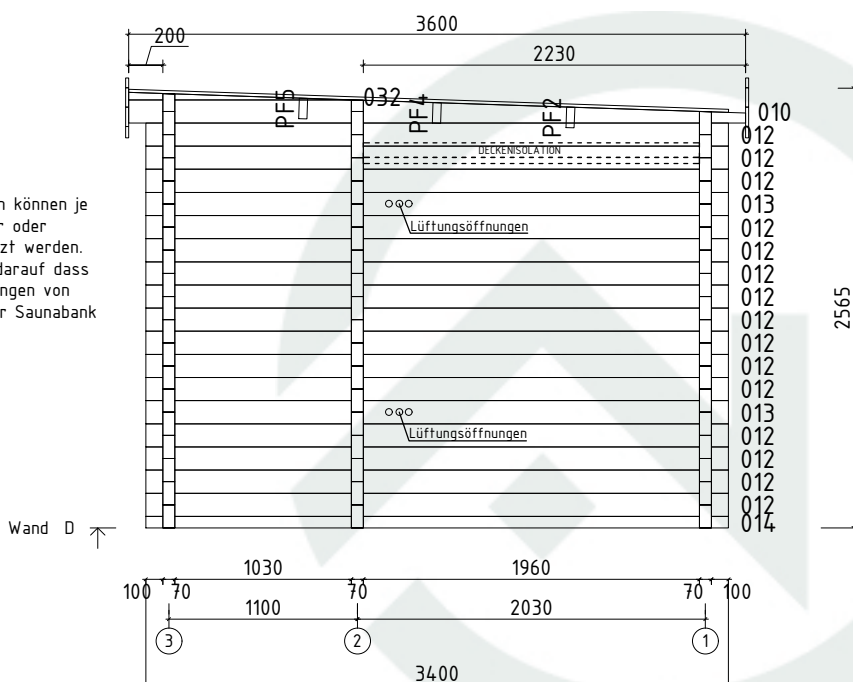

Die Bohlen mit Lüftungsöffnungen können je nach Bedarf höher oder niedriger eingesetzt werden. Bitte achten Sie darauf dass die Lüftungsöffnungen von innen nicht mit der Saunabank bedeckt werden!

Fußbodenbretter 350160

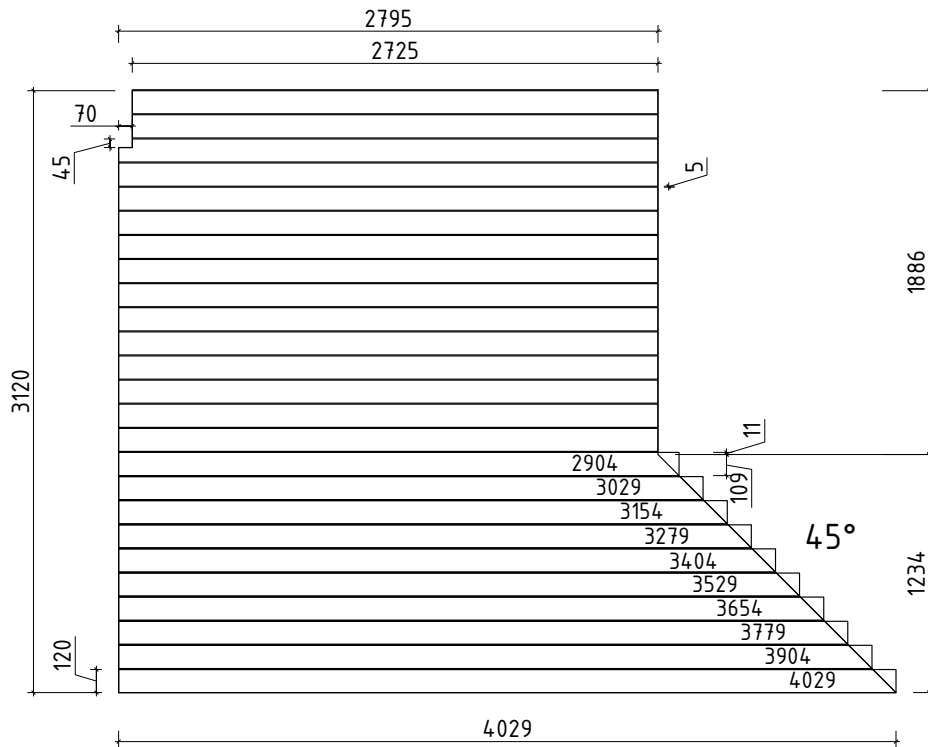

Sauna Yurika 340x460+ Terr.; 70

Zuschneiden der Fussbodenbretter 113x28mm

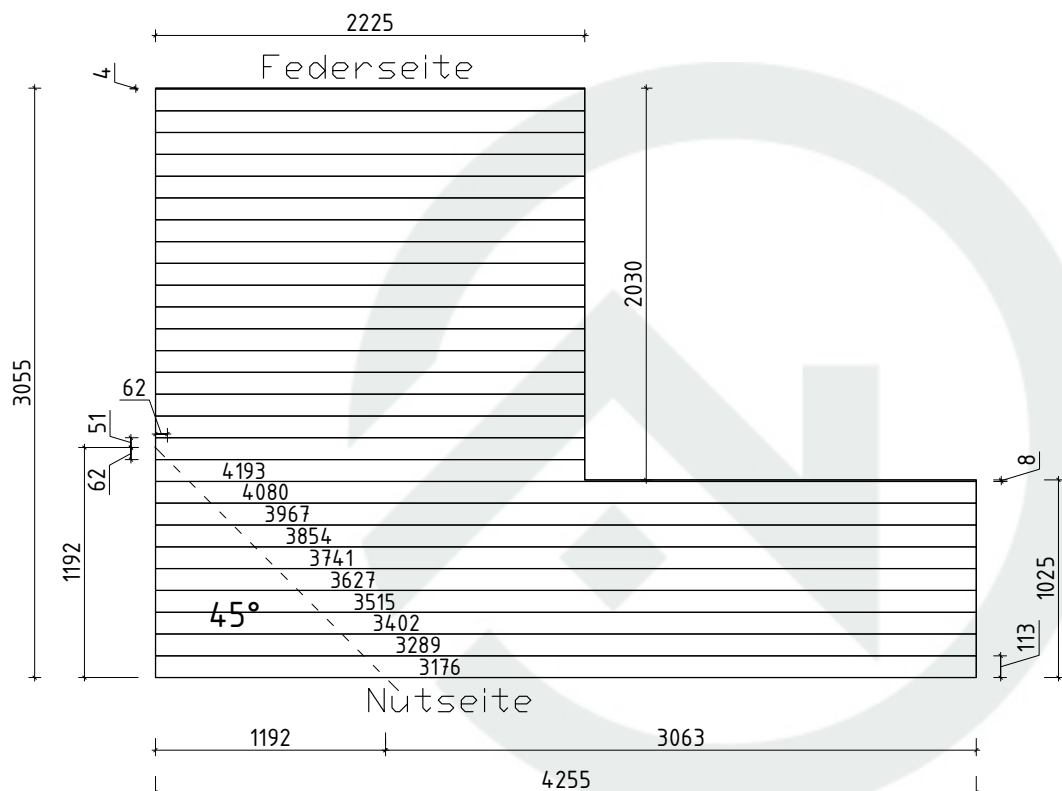

Montageanleitung für T-Leisten 350160

Montageanleitung für T-Leisten / Installing the door and window supports / Tenderlistu paigaldusjuhend.

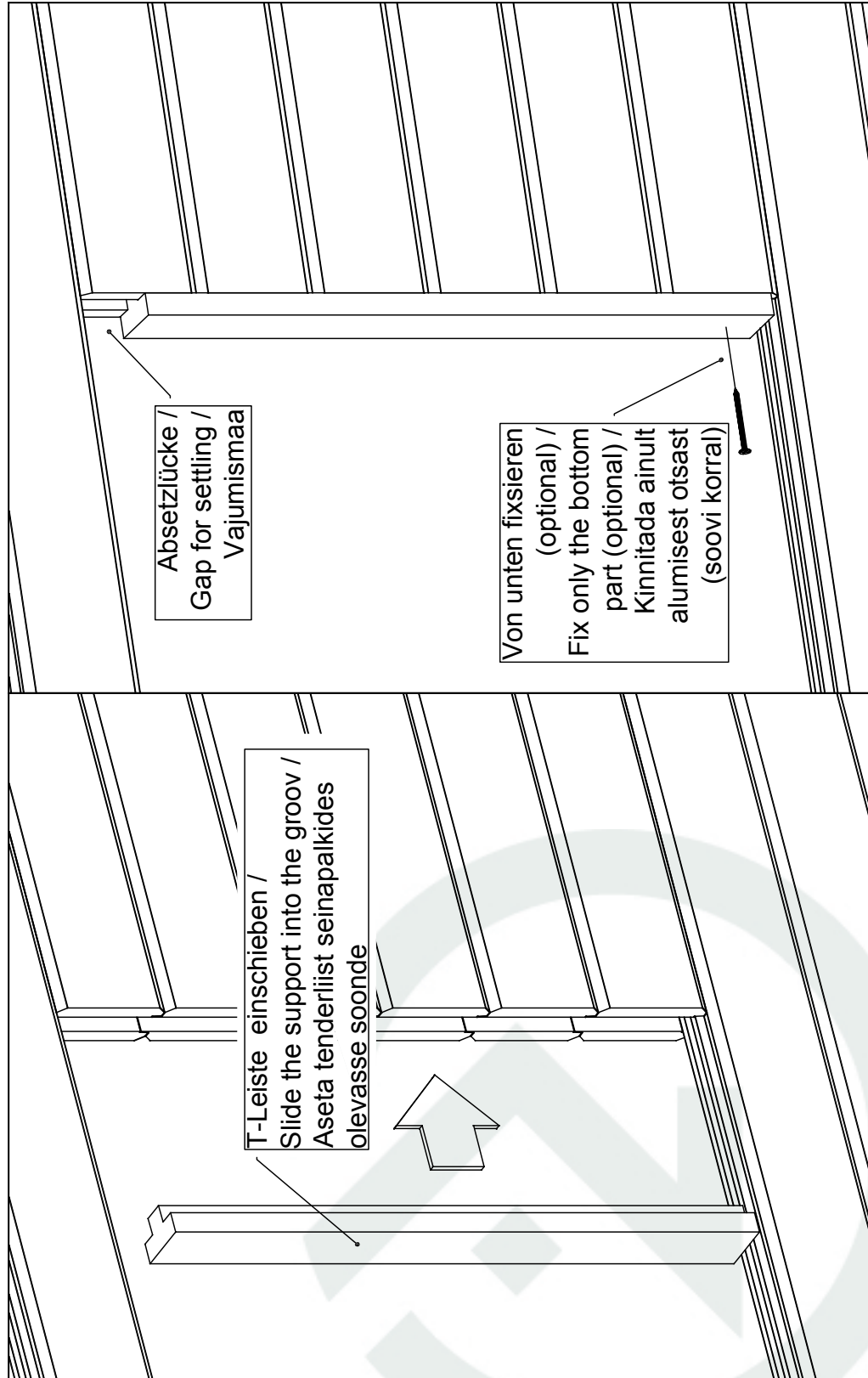

Details 350160

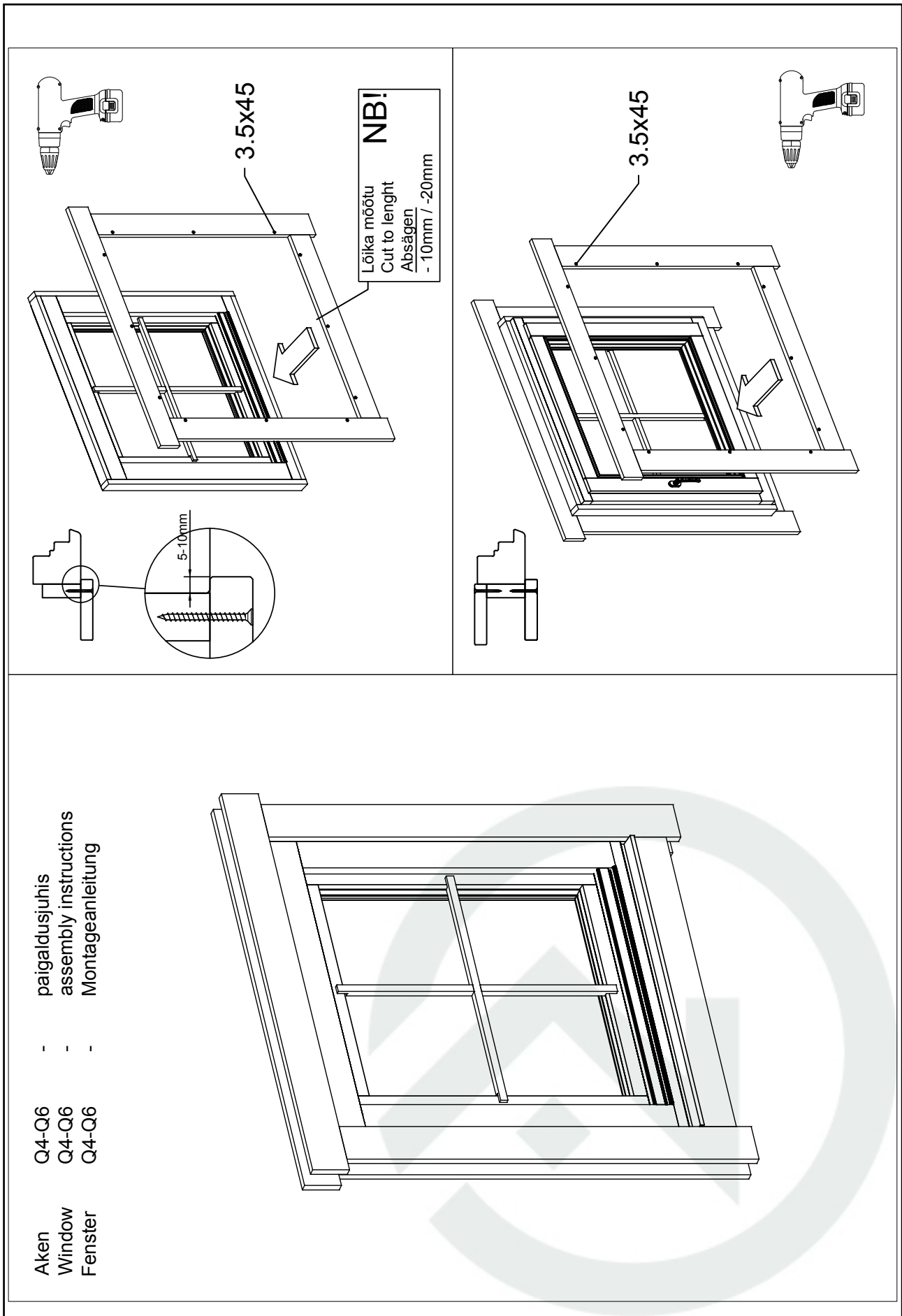

Details 350160

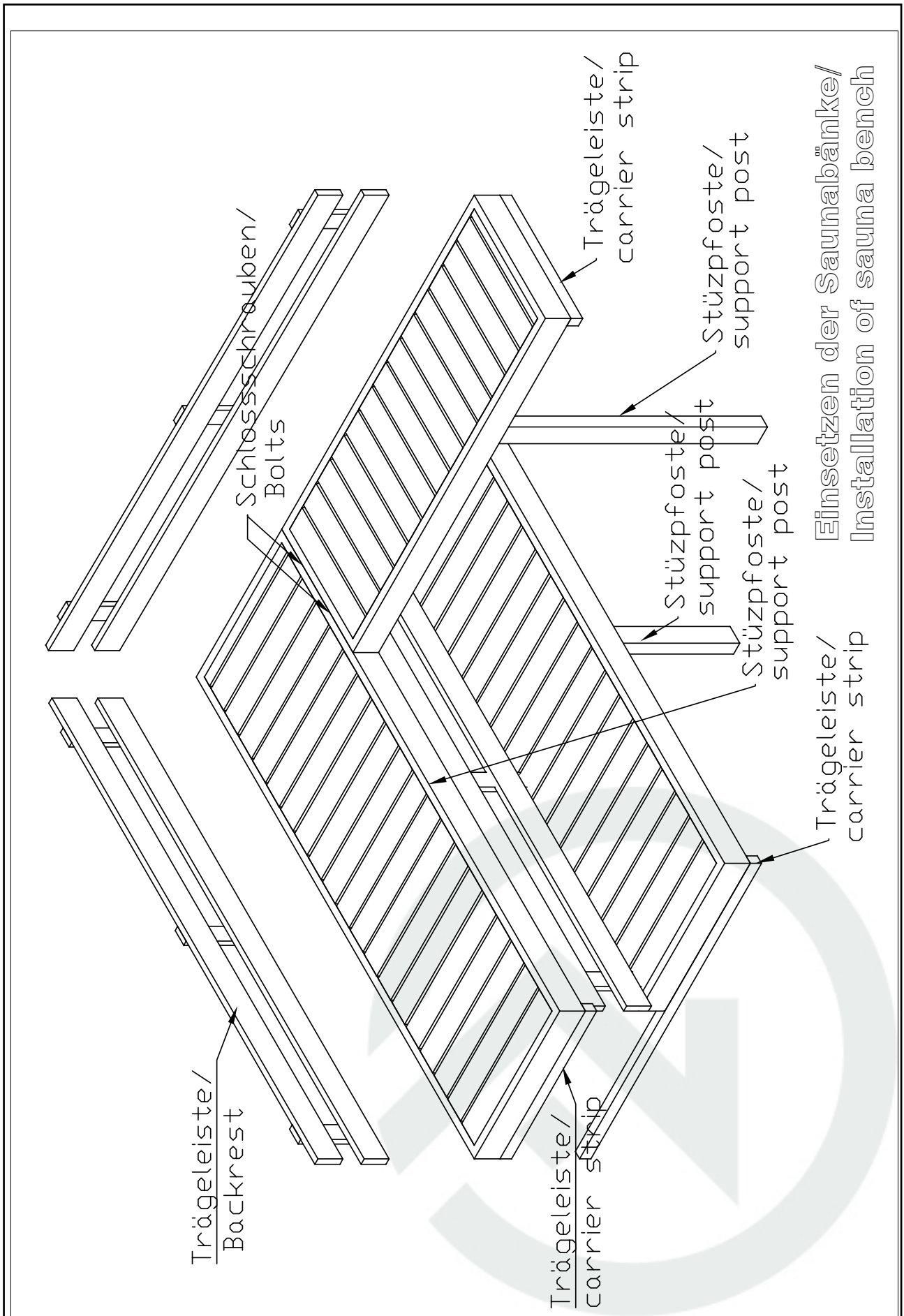

Details 350160

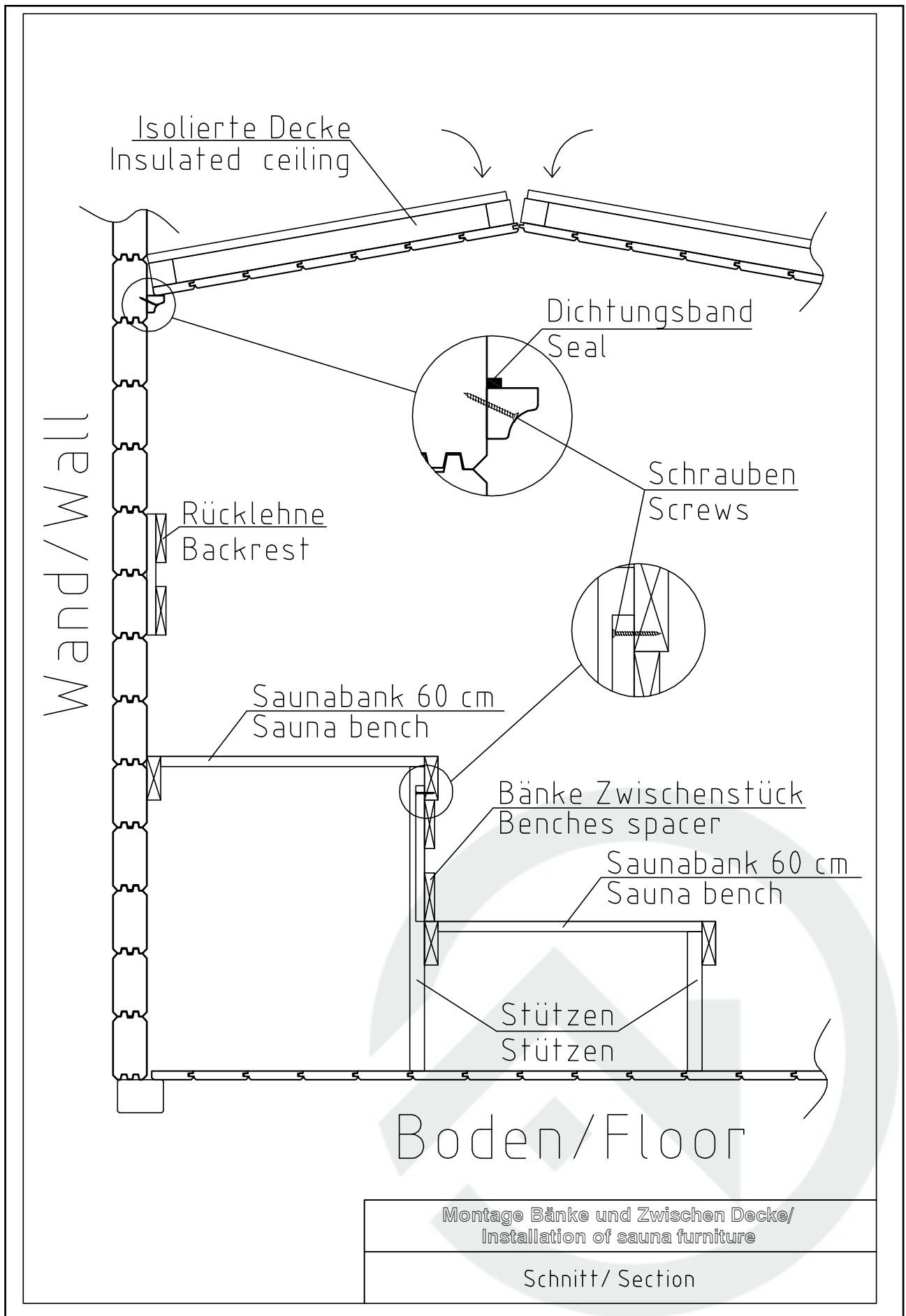

Details

350160

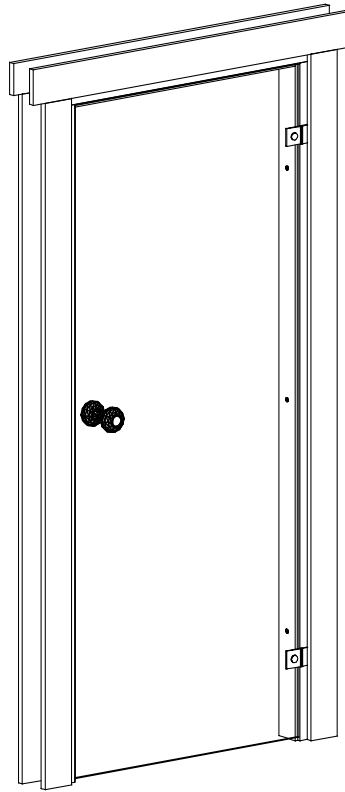

18x90 Blendleisten/
cover strips/piirdeliistud

Rahmenleisten
20x Wandstärke/
frame extensions
20x wall thickness/
laiendusliist
20x seinä paksus

18x90 Blendleisten/
cover strips/piirdeliistud

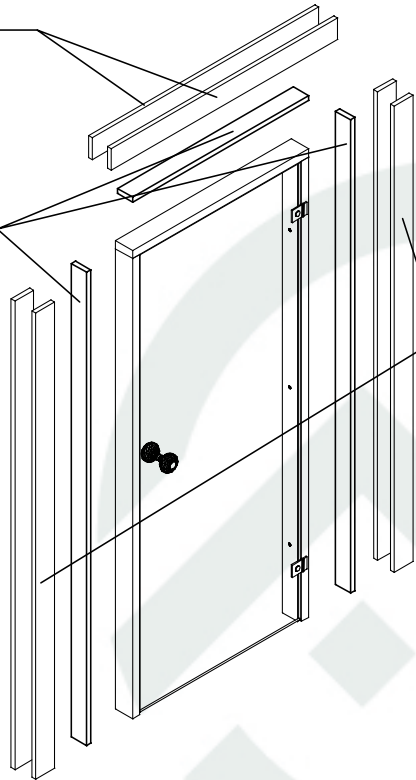

Details 350160

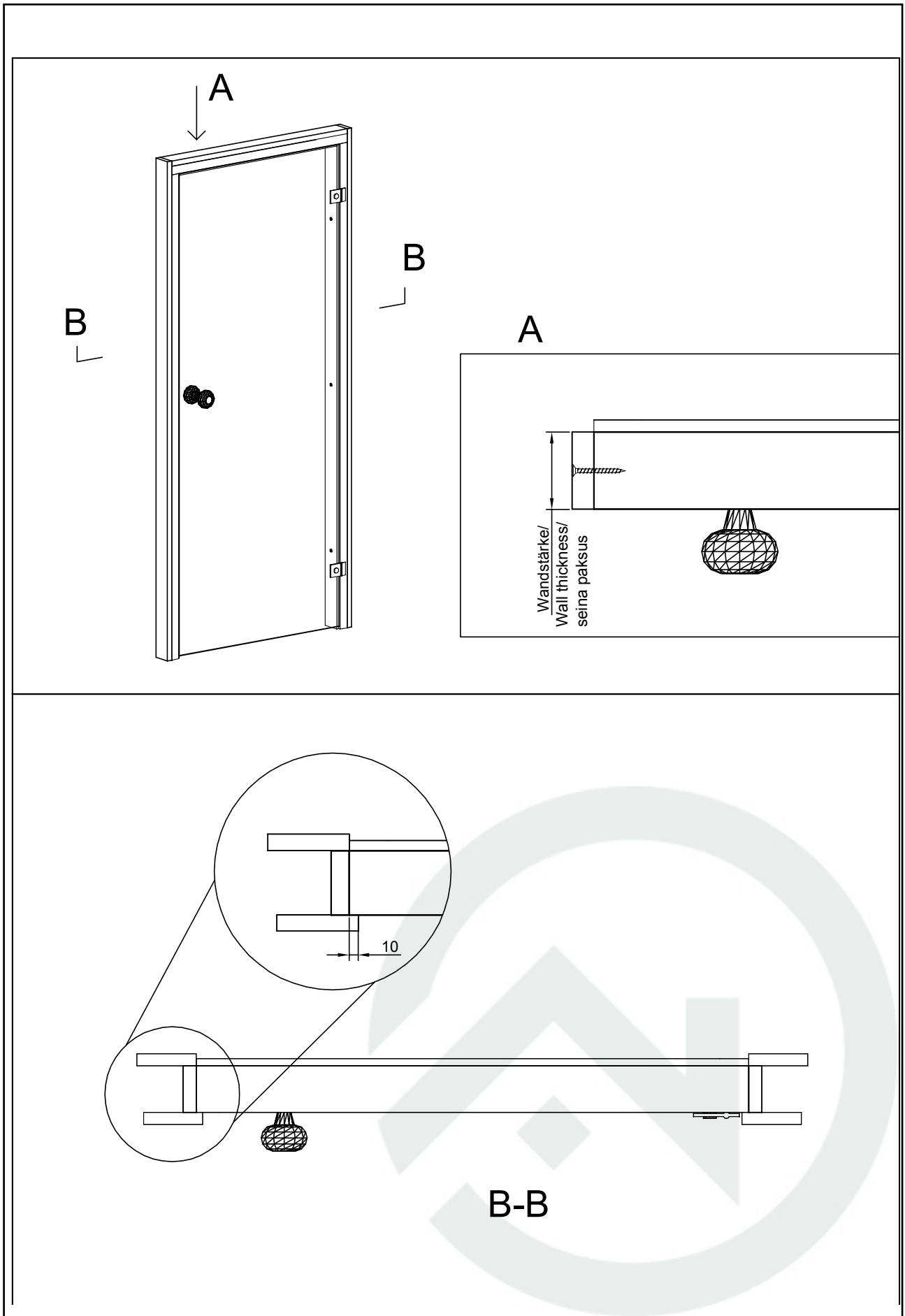

Details 350160

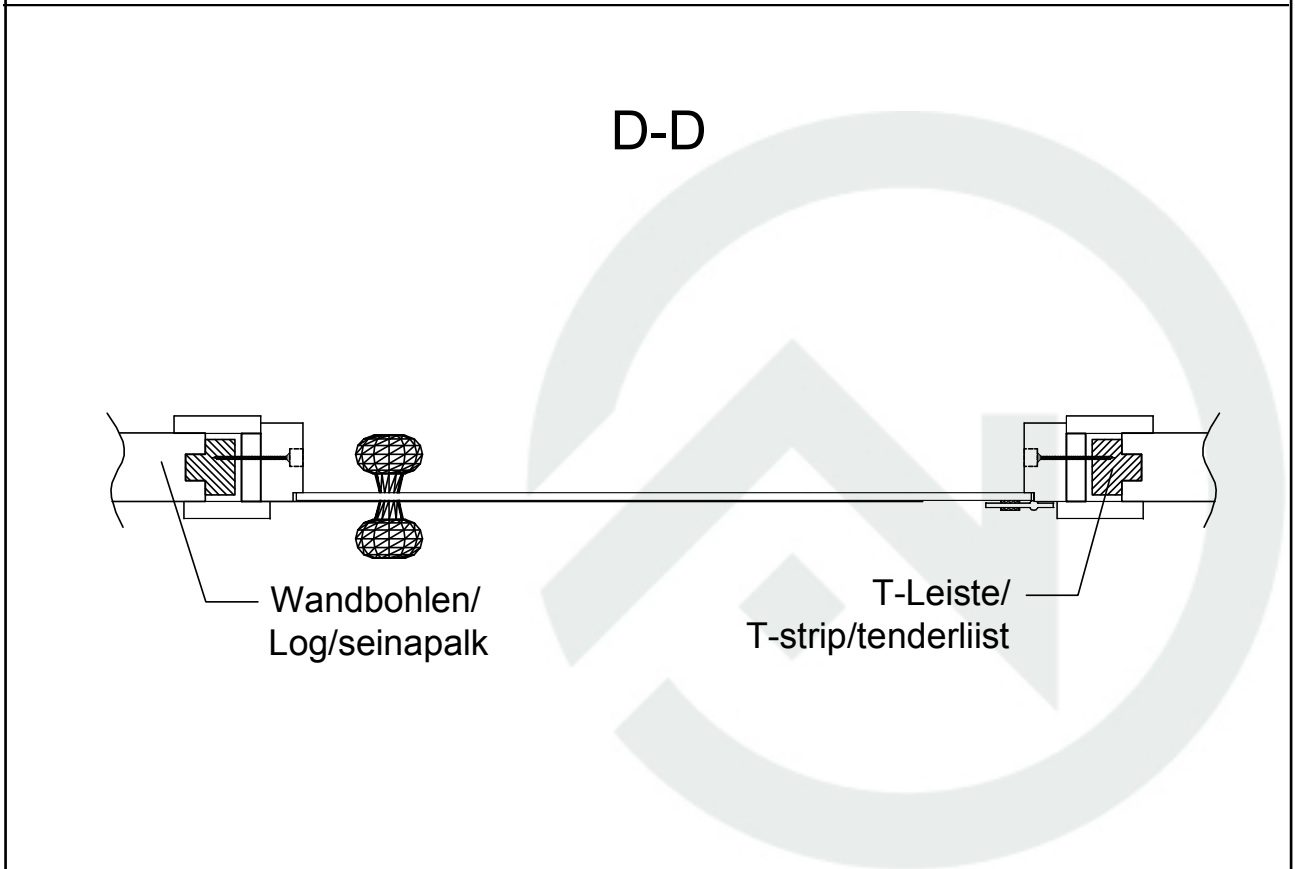
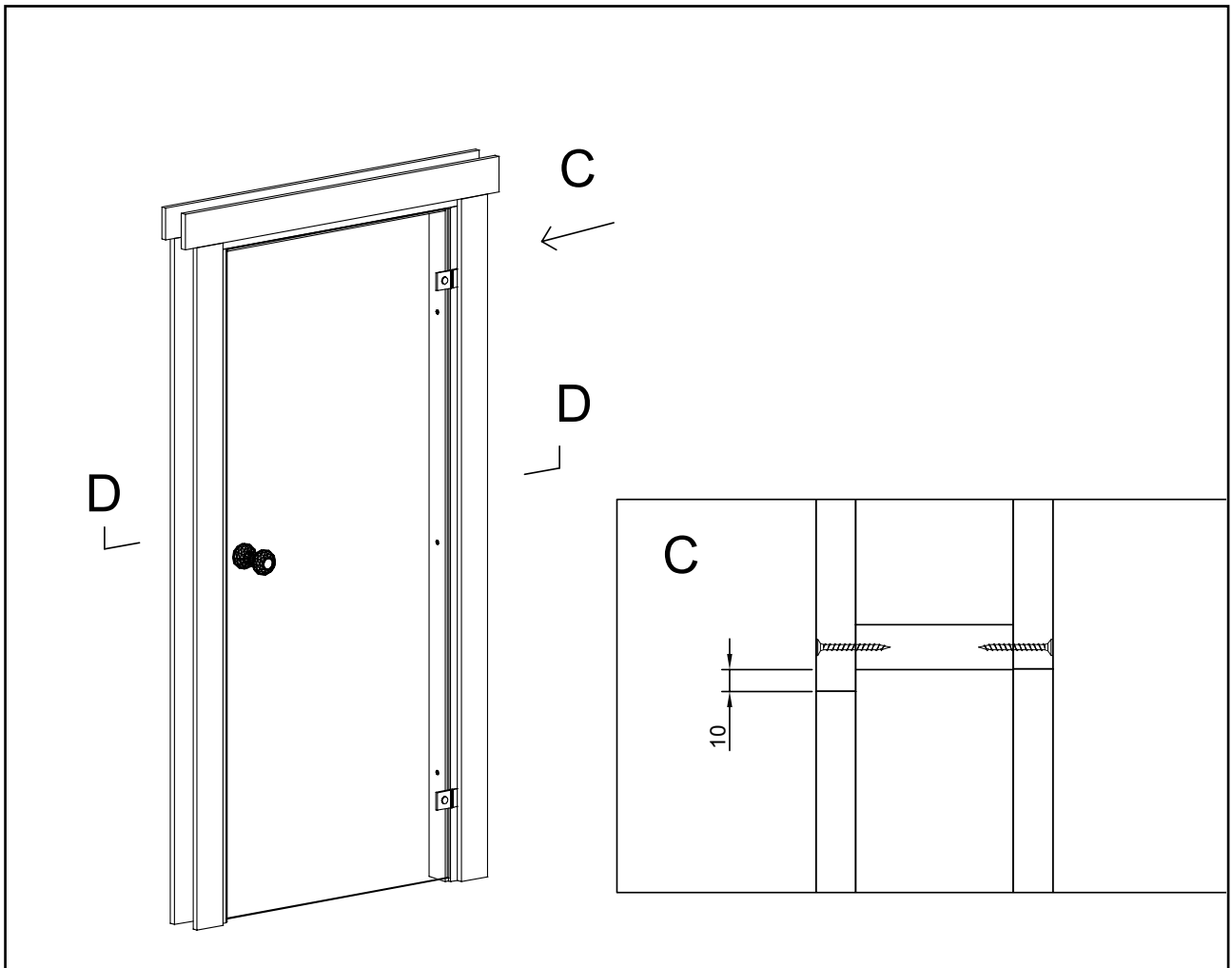

Details 350160

Step 1: Dachelement an den Wänden verschrauben.
Step 1: Screw canopy element to the wall.

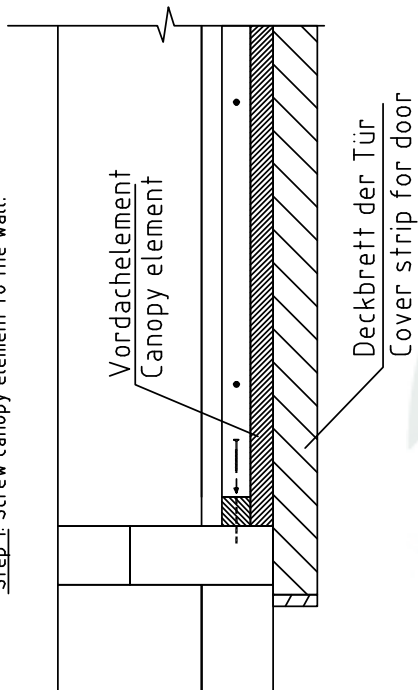

Step 2: Das Deckbrett muss von oben (durch das VD-Element) an das Dachelement verschraubt werden.
Step 2: Fasten cover strip to the canopy element.

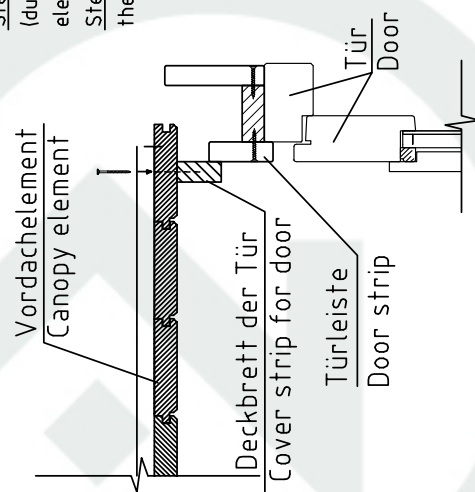

Step 3: Die Verkleidungsleisten in die richtige Länge schneiden und unter das VD-Element befestigen.
Step 3: Cut trim strips to size and fasten under the canopy element.

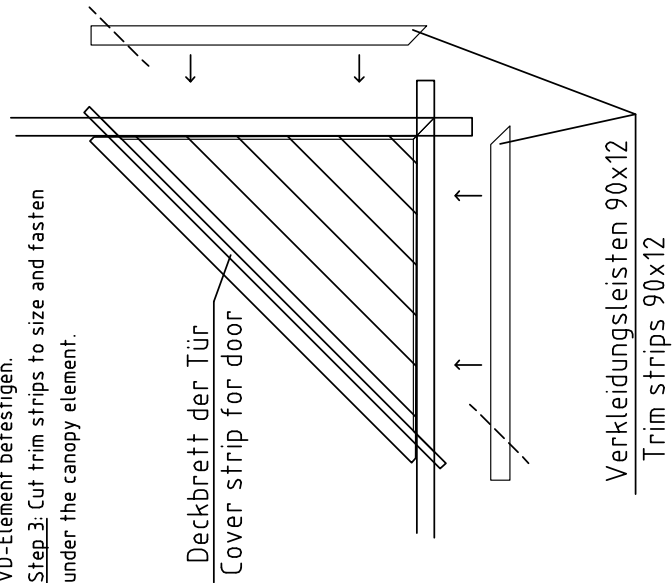

Vordachelement/Canopy element

Schnitt/Section